

Java Tutorial



JAVA TUTORIAL

Simply Easy Learning by tutorialspoint.com

tutorialspoint.com

ABOUT THE TUTORIAL

Java Tutorial

Java is a high-level programming language originally developed by Sun Microsystems and released in 1995. Java runs on a variety of platforms, such as Windows, Mac OS, and the various versions of UNIX. This tutorial gives a complete understanding of Java.

This reference will take you through simple and practical approach while learning Java Programming language.

Audience

This reference has been prepared for the beginners to help them understand the basic to advanced concepts related to Java Programming language.

Prerequisites

Before you start doing practice with various types of examples given in this reference, I'm making an assumption that you are already aware about what is a computer program and what is a computer programming language?

Copyright & Disclaimer Notice

©All the content and graphics on this tutorial are the property of tutorialspoint.com. Any content from tutorialspoint.com or this tutorial may not be redistributed or reproduced in any way, shape, or form without the written permission of tutorialspoint.com. Failure to do so is a violation of copyright laws.

This tutorial may contain inaccuracies or errors and tutorialspoint provides no guarantee regarding the accuracy of the site or its contents including this tutorial. If you discover that the tutorialspoint.com site or this tutorial content contains some errors, please contact us at webmaster@tutorialspoint.com

Table of Content

Java Tutorial	2
Audience	2
Prerequisites	2
Copyright & Disclaimer Notice	2
Java Overview	15
History of Java:.....	16
Tools you will need:.....	16
What is Next?	16
Java Environment Setup	17
Setting up the path for windows 2000/XP:	17
Setting up the path for windows 95/98/ME:.....	17
Setting up the path for Linux, UNIX, Solaris, FreeBSD:	17
Popular Java Editors:	18
What is Next?	18
Java Basic Syntax.....	19
First Java Program:	19
Basic Syntax:.....	20
Java Identifiers:	20
Java Modifiers:	21
Java Variables:.....	21
Java Arrays:	21
Java Enums:.....	21
Example:	21
Java Keywords:	22
Comments in Java.....	22
Using Blank Lines:.....	22
Inheritance:.....	22
Interfaces:.....	23
What is Next?	23
Java Object & Classes	24
Objects in Java:.....	24
Classes in Java:	25
Constructors:	25
Singleton Classes.....	26
Implementing Singletons:	26
Example 1:	26
Example 2:	27

Creating an Object:	27
Accessing Instance Variables and Methods:.....	27
Example:	28
Source file declaration rules:	28
Java Package:.....	29
Import statements:.....	29
A Simple Case Study:	29
What is Next?	31
Java Basic Data Types	32
Primitive Data Types:	32
byte:.....	32
short:	32
int:.....	33
long:.....	33
float:.....	33
double:.....	34
boolean:.....	34
char:	34
Reference Data Types:	34
Java Literals:	35
What is Next?	36
Java Variable Types	37
Local variables:	37
Example:	38
Example:	38
Instance variables:	38
Example:	39
Class/static variables:.....	40
Example:	40
What is Next?	41
Java Modifier Types	42
1. Java Access Modifiers.....	42
Default Access Modifier - No keyword:	42
Example:	42
Private Access Modifier - private:.....	43
Example:	43
Public Access Modifier - public:.....	43
Example:	43
Protected Access Modifier - protected:	44

Example:	44
Access Control and Inheritance:	44
2. Non Access Modifiers.....	44
Access Control Modifiers:.....	45
Non Access Modifiers:.....	45
Access Control Modifiers:.....	45
Non Access Modifiers:.....	45
What is Next?	46
Java Basic Operators.....	47
The Arithmetic Operators:	47
The Relational Operators:	48
Example	49
The Bitwise Operators:.....	49
Example	50
The Logical Operators:.....	51
Example	51
The Assignment Operators:	51
Example:	52
Misc Operators	53
Conditional Operator (?):.....	53
instanceof Operator:.....	54
Precedence of Java Operators:.....	54
What is Next?	55
Java Loop Control.....	56
The while Loop:	56
Syntax:	56
Example:	56
The do...while Loop:.....	57
Syntax:	57
Example:	57
The for Loop:.....	58
Syntax:	58
Example:	58
Enhanced for loop in Java:.....	59
Syntax:	59
Example:	59
The break Keyword:	59
Syntax:	60
Example:	60

The continue Keyword:.....	60
Syntax:	60
Example:	60
What is Next?	61
Java Decision Making	62
The if Statement:	62
Syntax:	62
Example:	62
The if...else Statement:	63
Syntax:	63
Example:	63
The if...else if...else Statement:	63
Syntax:	63
Example:	64
Nested if...else Statement:	64
Syntax:	64
Example:	64
The switch Statement:.....	65
Syntax:	65
Example:	65
What is Next?	66
Java Numbers	67
Example:	67
Number Methods:.....	68
xxxValue()	69
compareTo().....	70
equals()	71
valueOf().....	72
toString().....	73
parseInt()	74
abs()	75
ceil().....	76
floor()	77
rint()	78
round().....	78
min()	79
max()	80
exp()	81
log()	82

pow()	82
sqrt()	83
sin()	84
cos()	85
tan()	86
asin()	86
acos()	87
atan()	88
atan2()	89
toDegrees()	90
toRadians()	90
random()	91
What is Next?	92
Java Characters	93
Example:	93
Example:	93
Escape Sequences:	93
Example:	94
Character Methods:	94
isLetter()	95
isDigit()	96
isWhitespace()	96
isUpperCase()	97
isLowerCase()	98
toUpperCase()	99
toLowerCase()	99
toString()	100
What is Next?	101
Java Strings	102
Creating Strings:	102
String Length:	102
Concatenating Strings:	103
Creating Format Strings:	103
String Methods:	104
char charAt(int index)	106
int compareTo(Object o)	107
int compareTo(String anotherString)	108
int compareToIgnoreCase(String str)	109
String concat(String str)	110

boolean contentEquals(StringBuffer sb).....	111
static String copyValueOf(char[] data).....	112
boolean endsWith(String suffix)	113
boolean equals(Object anObject).....	114
boolean equalsIgnoreCase(String anotherString)	115
byte getBytes()	116
byte[] getBytes(String charsetName)	117
void getChars(int srcBegin, int srcEnd, char[] dst, int dstBegin)	118
int hashCode().....	119
int indexOf(int ch)	120
int indexOf(int ch, int fromIndex)	121
int indexOf(String str)	123
int indexOf(String str, int fromIndex).....	124
String intern().....	126
int lastIndexOf(int ch)	127
int lastIndexOf(int ch, int fromIndex).....	128
int lastIndexOf(String str).....	130
int lastIndexOf(String str, int fromIndex).....	131
int length()	133
boolean matches(String regex)	133
boolean regionMatches(boolean ignoreCase, int toffset,	134
String other, int ooffset, int len)	134
boolean regionMatches(int toffset, String other, int ooffset, int len)	136
String replace(char oldChar, char newChar).....	137
String replaceAll(String regex, String replacement)	138
String replaceFirst(String regex, String replacement)	139
String[] split(String regex).....	140
String[] split(String regex, int limit).....	141
boolean startsWith(String prefix)	143
boolean startsWith(String prefix, int toffset)	144
CharSequence subSequence(int beginIndex, int endIndex).....	145
String substring(int beginIndex).....	146
String substring(int beginIndex, int endIndex).....	147
char[] toCharArray().....	148
String toLowerCase()	148
String toLowerCase(Locale locale)	149
String toString()	150
String toUpperCase()	151
String toUpperCase(Locale locale)	152

TUTORIALS POINT

Simply Easy Learning

String trim().....	153
static String valueOf(primitive data type x).....	154
Java Arrays	156
Declaring Array Variables:.....	156
Example:	156
Creating Arrays:	156
Example:	157
Processing Arrays:	157
Example:	157
The foreach Loops:	158
Example:	158
Passing Arrays to Methods:	158
Returning an Array from a Method:	159
The Arrays Class:.....	159
Java Date and Time	160
Getting Current Date & Time	161
Date Comparison:	161
Date Formatting using SimpleDateFormat:	161
Simple DateFormat format codes:.....	162
Date Formatting using printf:	162
Date and Time Conversion Characters:	164
Parsing Strings into Dates:	165
Sleeping for a While:	165
Measuring Elapsed Time:.....	166
GregorianCalendar Class:.....	166
Example:	168
Java Regular Expressions	170
Capturing Groups:	170
Example:	171
Regular Expression Syntax:	171
Methods of the Matcher Class:.....	172
Index Methods:	172
Study Methods:	173
Replacement Methods:	173
The start and end Methods:	174
The <i>matches</i> and <i>lookingAt</i> Methods:	174
The <i>replaceFirst</i> and <i>replaceAll</i> Methods:	175
The <i>appendReplacement</i> and <i>appendTail</i> Methods:	175
PatternSyntaxException Class Methods:	176

Java Methods.....	177
Creating a Method:.....	177
Example:	178
Calling a Method:	178
Example:	178
The void Keyword:.....	179
Example:	179
Passing Parameters by Values:	180
Example:	180
Overloading Methods:	181
The Scope of Variables:	181
Using Command-Line Arguments:	182
Example:	182
The Constructors:.....	183
Example:	183
Example:	183
Variable Arguments(var-args):	184
Example:	184
The finalize() Method:.....	184
Java Streams, Files and I/O.....	186
Byte Streams.....	186
Character Streams	187
Standard Streams	188
Reading and Writing Files:	189
FileInputStream:	189
ByteArrayInputStream	190
Example:	190
DataInputStream	191
Example:	192
FileOutputStream:	193
ByteArrayOutputStream	193
Example:	194
DataOutputStream	195
Example:	195
Example:	196
File Navigation and I/O:.....	197
File Class.....	197
Example:	200
FileReader Class.....	200

Example:	201
FileWriter Class	201
Example:	202
Directories in Java:.....	203
Creating Directories:.....	203
Listing Directories:.....	203
Java Exceptions	205
Exception Hierarchy:	205
Exceptions Methods:	207
Catching Exceptions:.....	207
Example:	208
Multiple catch Blocks:.....	208
Example:	209
The throws/throw Keywords:	209
The finally Keyword	209
Example:	210
Declaring you own Exception:	211
Example:	211
Common Exceptions:	213
Java Inheritance.....	214
IS-A Relationship:.....	214
Example:	215
Example:	215
The instanceof Keyword:.....	215
HAS-A relationship:	216
Java Overriding	217
Example:	217
Rules for method overriding:	218
Using the super keyword:.....	219
Java Polymorphism.....	220
Example:	220
Virtual Methods:	221
Java Abstraction	224
Abstract Class:	224
Extending Abstract Class:	225
Abstract Methods:	226
Java Encapsulation	228
Example:	228
Benefits of Encapsulation:.....	229

Java Interfaces.....	230
Declaring Interfaces:	231
Example:	231
Example:	231
Implementing Interfaces:.....	231
Extending Interfaces:.....	232
Extending Multiple Interfaces:	233
Tagging Interfaces:.....	233
Java Packages.....	234
Creating a package:	234
Example:	234
The import Keyword:	235
Example:	235
The Directory Structure of Packages:	236
Set CLASSPATH System Variable:	237
Java Data Structures	239
The Enumeration:.....	239
Example:	240
The BitSet.....	240
Example:	242
The Vector.....	243
Example:	246
The Stack	247
Example:	248
The Dictionary	249
Map Interface	249
Example:	250
The Hashtable	251
Example:	252
The Properties.....	253
Example:	254
Java Collections.....	256
The Collection Interfaces:.....	256
The Collection Classes:.....	257
The Collection Algorithms:	258
How to use an Iterator?	259
Using Java Iterator	259
The Methods Declared by Iterator:.....	259
The Methods Declared by ListIterator:	260

Example:	260
How to use a Comparator?	261
Using Java Comparator.....	261
The compare Method:	262
The equals Method:.....	262
Example:	262
Summary:	263
Java Generics	264
Generic Methods:	264
Example:	264
Bounded Type Parameters:	265
Example:	265
Generic Classes:	266
Example:	266
Java Serialization	268
Serializing an Object:	269
Deserializing an Object:	269
Java Networking	271
Url Processing	271
URL Class Methods:	272
Example:	273
URLConnections Class Methods:	273
Example:	274
Socket Programming:.....	275
ServerSocket Class Methods:	276
Socket Class Methods:.....	277
InetAddress Class Methods:	278
Socket Client Example:	278
Socket Server Example:.....	279
Java Sending E-mail	281
Send a Simple E-mail:.....	281
Send an HTML E-mail:	282
Send Attachment in E-mail:.....	284
User Authentication Part:	285
Java Multithreading	286
Life Cycle of a Thread:	286
Thread Priorities:	287
Create Thread by Implementing Runnable Interface:	287
STEP 1:	288

STEP 2:	288
STEP 3	288
Example:	288
Create Thread by Extending Thread Class:	289
STEP 1	289
STEP 2	289
Example:	289
Thread Methods:	291
Example:	292
Major Java Multithreading Concepts:	293
What is Thread synchronization?	294
Multithreading example without Synchronization:	294
Multithreading example with Synchronization:	295
Handling threads inter communication	297
Example:	297
Handling threads deadlock	299
Example:	299
Deadlock Solution Example:	300
Major thread operatios	301
Example:	301
Java Applet Basics	304
Life Cycle of an Applet:	304
A "Hello, World" Applet:.....	305
The Applet CLASS:	305
Invoking an Applet:.....	306
Getting Applet Parameters:	307
Specifying Applet Parameters:	308
Application Conversion to Applets:.....	308
Event Handling:	309
Displaying Images:	310
Playing Audio:	311
Java Documentation	313
What is Javadoc?	313
The javadoc Tags:.....	314
Example:	315
Java Library Classes.....	317

Java Overview

Java programming language was originally developed by Sun Microsystems which was initiated by James Gosling and released in 1995 as core component of Sun Microsystems' Java platform (Java 1.0 [J2SE]).

As of December 2008, the latest release of the Java Standard Edition is 6 (J2SE). With the advancement of Java and its widespread popularity, multiple configurations were built to suite various types of platforms. Ex: J2EE for Enterprise Applications, J2ME for Mobile Applications.

Sun Microsystems has renamed the new J2 versions as Java SE, Java EE and Java ME, respectively. Java is guaranteed to be **Write Once, Run Anywhere**.

Java is:

- **Object Oriented:** In Java, everything is an Object. Java can be easily extended since it is based on the Object model.
- **Platform independent:** Unlike many other programming languages including C and C++, when Java is compiled, it is not compiled into platform specific machine, rather into platform independent byte code. This byte code is distributed over the web and interpreted by virtual Machine (JVM) on whichever platform it is being run.
- **Simple:** Java is designed to be easy to learn. If you understand the basic concept of OOP, Java would be easy to master.
- **Secure:** With Java's secure feature, it enables to develop virus-free, tamper-free systems. Authentication techniques are based on public-key encryption.
- **Architectural-neutral:** Java compiler generates an architecture-neutral object file format, which makes the compiled code to be executable on many processors, with the presence of Java runtime system.
- **Portable:** Being architectural-neutral and having no implementation dependent aspects of the specification makes Java portable. Compiler in Java is written in ANSI C with a clean portability boundary which is a POSIX subset.
- **Robust:** Java makes an effort to eliminate error prone situations by emphasizing mainly on compile time error checking and runtime checking.

- **Multithreaded:** With Java's multithreaded feature, it is possible to write programs that can do many tasks simultaneously. This design feature allows developers to construct smoothly running interactive applications.
- **Interpreted:** Java byte code is translated on the fly to native machine instructions and is not stored anywhere. The development process is more rapid and analytical since the linking is an incremental and lightweight process.
- **High Performance:** With the use of Just-In-Time compilers, Java enables high performance.
- **Distributed:** Java is designed for the distributed environment of the internet.
- **Dynamic:** Java is considered to be more dynamic than C or C++ since it is designed to adapt to an evolving environment. Java programs can carry extensive amount of run-time information that can be used to verify and resolve accesses to objects on run-time.

History of Java:

James Gosling initiated the Java language project in June 1991 for use in one of his many set-top box projects. The language, initially called Oak after an oak tree that stood outside Gosling's office, also went by the name Green and ended up later being renamed as Java, from a list of random words.

Sun released the first public implementation as Java 1.0 in 1995. It promised **Write Once, Run Anywhere** (WORA), providing no-cost run-times on popular platforms.

On 13 November 2006, Sun released much of Java as free and open source software under the terms of the GNU General Public License (GPL).

On 8 May 2007, Sun finished the process, making all of Java's core code free and open-source, aside from a small portion of code to which Sun did not hold the copyright.

Tools you will need:

For performing the examples discussed in this tutorial, you will need a Pentium 200-MHz computer with a minimum of 64 MB of RAM (128 MB of RAM recommended).

You also will need the following softwares:

- Linux 7.1 or Windows 95/98/2000/XP operating system.
- Java JDK 5
- Microsoft Notepad or any other text editor

This tutorial will provide the necessary skills to create GUI, networking, and Web applications using Java.

What is Next?

Next chapter will guide you to where you can obtain Java and its documentation. Finally, it instructs you on how to install Java and prepare an environment to develop Java applications.

Java Environment Setup

Before we proceed further, it is important that we set up the Java environment correctly. This section guides you on how to download and set up Java on your machine. Please follow the following steps to set up the environment.

Java SE is freely available from the link [Download Java](#). So you download a version based on your operating system.

Follow the instructions to download Java and run the `.exe` to install Java on your machine. Once you installed Java on your machine, you would need to set environment variables to point to correct installation directories:

Setting up the path for windows 2000/XP:

Assuming you have installed Java in `c:\Program Files\java\jdk` directory:

- Right-click on 'My Computer' and select 'Properties'.
- Click on the 'Environment variables' button under the 'Advanced' tab.
- Now, alter the 'Path' variable so that it also contains the path to the Java executable. Example, if the path is currently set to 'C:\WINDOWS\SYSTEM32', then change your path to read 'C:\WINDOWS\SYSTEM32;c:\Program Files\java\jdk\bin'.

Setting up the path for windows 95/98/ME:

Assuming you have installed Java in `c:\Program Files\java\jdk` directory:

- Edit the 'C:\autoexec.bat' file and add the following line at the end:
`'SET PATH=%PATH%;C:\Program Files\java\jdk\bin'`

Setting up the path for Linux, UNIX, Solaris, FreeBSD:

Environment variable PATH should be set to point to where the Java binaries have been installed. Refer to your shell documentation if you have trouble doing this.

Example, if you use `bash` as your shell, then you would add the following line to the end of your `!.bashrc`: `export PATH=/path/to/java:$PATH'`

Popular Java Editors:

To write your Java programs, you will need a text editor. There are even more sophisticated IDEs available in the market. But for now, you can consider one of the following:

- **Notepad:** On Windows machine, you can use any simple text editor like Notepad (Recommended for this tutorial), TextPad.
- **Netbeans:** Is a Java IDE that is open-source and free which can be downloaded from <http://www.netbeans.org/index.html>.
- **Eclipse:** Is also a Java IDE developed by the eclipse open-source community and can be downloaded from <http://www.eclipse.org/>.

What is Next?

Next chapter will teach you how to write and run your first Java program and some of the important basic syntaxes in Java needed for developing applications.

Java Basic Syntax

W

hen we consider a Java program, it can be defined as a collection of objects that communicate via invoking each other's methods. Let us now briefly look into what do class, object, methods and instance variables mean.

- **Object** - Objects have states and behaviors. Example: A dog has states-color, name, breed as well as behaviors -wagging, barking, eating. An object is an instance of a class.
- **Class** - A class can be defined as a template/blue print that describes the behaviors/states that object of its type support.
- **Methods** - A method is basically a behavior. A class can contain many methods. It is in methods where the logics are written, data is manipulated and all the actions are executed.
- **Instance Variables** - Each object has its unique set of instance variables. An object's state is created by the values assigned to these instance variables.

First Java Program:

Let us look at a simple code that would print the words *Hello World*.

```
public class MyFirstJavaProgram{  
  
    /* This is my first java program.  
     * This will print 'Hello World' as the output  
     */  
  
    public static void main(String[]args){  
        System.out.println("Hello World");// prints Hello World  
    }  
}
```

Let's look at how to save the file, compile and run the program. Please follow the steps given below:

- Open notepad and add the code as above.
- Save the file as: MyFirstJavaProgram.java.
- Open a command prompt window and go to the directory where you saved the class. Assume it's C:\.
- Type ' javac MyFirstJavaProgram.java ' and press enter to compile your code. If there are no errors in your code, the command prompt will take you to the next line(Assumption : The path variable is set).

TUTORIALS POINT

Simply Easy Learning

- Now, type ' java MyFirstJavaProgram ' to run your program.
- You will be able to see ' Hello World ' printed on the window.

```
C :> javac MyFirstJavaProgram.java
C :> java MyFirstJavaProgram
HelloWorld
```

Basic Syntax:

About Java programs, it is very important to keep in mind the following points.

- **Case Sensitivity** - Java is case sensitive, which means identifier **Hello** and **hello** would have different meaning in Java.
- **Class Names** - For all class names, the first letter should be in Upper Case.

If several words are used to form a name of the class, each inner word's first letter should be in Upper Case.

Example *class MyFirstJavaClass*

- **Method Names** - All method names should start with a Lower Case letter.

If several words are used to form the name of the method, then each inner word's first letter should be in Upper Case.

Example *public void myMethodName()*

- **Program File Name** - Name of the program file should exactly match the class name.

When saving the file, you should save it using the class name (Remember Java is case sensitive) and append '.java' to the end of the name (if the file name and the class name do not match your program will not compile).

Example : Assume 'MyFirstJavaProgram' is the class name, then the file should be saved as '*MyFirstJavaProgram.java*'

- **public static void main(String args[])** - Java program processing starts from the main() method, which is a mandatory part of every Java program.

Java Identifiers:

All Java components require names. Names used for classes, variables and methods are called identifiers.

In Java, there are several points to remember about identifiers. They are as follows:

- All identifiers should begin with a letter (A to Z or a to z), currency character (\$) or an underscore (_).
- After the first character, identifiers can have any combination of characters.
- A keyword cannot be used as an identifier.
- Most importantly identifiers are case sensitive.
- Examples of legal identifiers: age, \$salary, _value, __1_value
- Examples of illegal identifiers: 123abc, -salary

Java Modifiers:

Like other languages, it is possible to modify classes, methods, etc., by using modifiers. There are two categories of modifiers:

- **Access Modifiers:** default, public, protected, private
- **Non-access Modifiers:** final, abstract, strictfp

We will be looking into more details about modifiers in the next section.

Java Variables:

We would see following type of variables in Java:

- Local Variables
- Class Variables (Static Variables)
- Instance Variables (Non-static variables)

Java Arrays:

Arrays are objects that store multiple variables of the same type. However, an array itself is an object on the heap. We will look into how to declare, construct and initialize in the upcoming chapters.

Java Enums:

Enums were introduced in java 5.0. Enums restrict a variable to have one of only a few predefined values. The values in this enumerated list are called enums.

With the use of enums, it is possible to reduce the number of bugs in your code.

For example, if we consider an application for a fresh juice shop, it would be possible to restrict the glass size to small, medium and large. This would make sure that it would not allow anyone to order any size other than the small, medium or large.

Example:

```
class FreshJuice{
    enum FreshJuiceSize{ SMALL, MEDUIM, LARGE }
    FreshJuiceSize size;
}

public class FreshJuiceTest{

    public static void main(String args[]){
        FreshJuice juice =new FreshJuice();
        juice.size =FreshJuice.FreshJuiceSize.MEDUIM ;
    }
}
```

Note: enums can be declared as their own or inside a class. Methods, variables, constructors can be defined inside enums as well.

Java Keywords:

The following list shows the reserved words in Java. These reserved words may not be used as constant or variable or any other identifier names.

abstract	assert	boolean	break
byte	case	catch	char
class	const	continue	default
do	double	else	enum
extends	final	finally	float
for	goto	if	implements
import	instanceof	int	interface
long	native	new	package
private	protected	public	return
short	static	strictfp	super
switch	synchronized	this	throw
throws	transient	try	void
volatile	while		

Comments in Java

Java supports single-line and multi-line comments very similar to c and c++. All characters available inside any comment are ignored by Java compiler.

```
public class MyFirstJavaProgram{

    /* This is my first java program.
       * This will print 'Hello World' as the output
       * This is an example of multi-line comments.
       */

    public static void main(String[]args){
    // This is an example of single line comment
    /* This is also an example of single line comment. */
    System.out.println("Hello World");
    }
}
```

Using Blank Lines:

A line containing only whitespace, possibly with a comment, is known as a blank line, and Java totally ignores it.

Inheritance:

Java classes can be derived from classes. Basically, if you need to create a new class and here is already a class that has some of the code you require, then it is possible to derive your new class from the already existing code.

TUTORIALS POINT

Simply Easy Learning

This concept allows you to reuse the fields and methods of the existing class without having to rewrite the code in a new class. In this scenario, the existing class is called the superclass and the derived class is called the subclass.

Interfaces:

In Java language, an interface can be defined as a contract between objects on how to communicate with each other. Interfaces play a vital role when it comes to the concept of inheritance.

An interface defines the methods, a deriving class(subclass) should use. But the implementation of the methods is totally up to the subclass.

What is Next?

The next section explains about Objects and classes in Java programming. At the end of the session, you will be able to get a clear picture as to what are objects and what are classes in Java.

Java Object & Classes

Java is an Object-Oriented Language. As a language that has the Object Oriented feature, Java supports the following fundamental concepts:

- Polymorphism
- Inheritance
- Encapsulation
- Abstraction
- Classes
- Objects
- Instance
- Method
- Message Parsing

In this chapter, we will look into the concepts Classes and Objects.

- **Object** - Objects have states and behaviors. Example: A dog has states-color, name, breed as well as behaviors -wagging, barking, eating. An object is an instance of a class.
- **Class** - A class can be defined as a template/blue print that describes the behaviors/states that object of its type support.

Objects in Java:

Let us now look deep into what are objects. If we consider the real-world we can find many objects around us, Cars, Dogs, Humans, etc. All these objects have a state and behavior.

If we consider a dog, then its state is - name, breed, color, and the behavior is - barking, wagging, running

If you compare the software object with a real world object, they have very similar characteristics.

Software objects also have a state and behavior. A software object's state is stored in fields and behavior is shown via methods.

So in software development, methods operate on the internal state of an object and the object-to-object communication is done via methods.

Classes in Java:

A class is a blue print from which individual objects are created.

A sample of a class is given below:

```
public class Dog{
String breed;
int age;
String color;

void barking(){
}

void hungry(){
}

void sleeping(){
}
}
```

A class can contain any of the following variable types.

- **Local variables:** Variables defined inside methods, constructors or blocks are called local variables. The variable will be declared and initialized within the method and the variable will be destroyed when the method has completed.
- **Instance variables:** Instance variables are variables within a class but outside any method. These variables are instantiated when the class is loaded. Instance variables can be accessed from inside any method, constructor or blocks of that particular class.
- **Class variables:** Class variables are variables declared within a class, outside any method, with the static keyword.

A class can have any number of methods to access the value of various kinds of methods. In the above example, barking(), hungry() and sleeping() are methods.

Below mentioned are some of the important topics that need to be discussed when looking into classes of the Java Language.

Constructors:

When discussing about classes, one of the most important subtopic would be constructors. Every class has a constructor. If we do not explicitly write a constructor for a class the Java compiler builds a default constructor for that class.

Each time a new object is created, at least one constructor will be invoked. The main rule of constructors is that they should have the same name as the class. A class can have more than one constructor.

Example of a constructor is given below:

```
public class Puppy{
public Puppy(){
}

public Puppy(String name){
// This constructor has one parameter, name.
}
}
```

Java also supports [Singleton Classes](#) where you would be able to create only one instance of a class.

Singleton Classes

The Singleton's purpose is to control object creation, limiting the number of objects to one only. Since there is only one Singleton instance, any instance fields of a Singleton will occur only once per class, just like static fields. Singletons often control access to resources such as database connections or sockets.

For example, if you have a license for only one connection for your database or your JDBC driver has trouble with multithreading, the Singleton makes sure that only one connection is made or that only one thread can access the connection at a time.

Implementing Singletons:

Example 1:

The easiest implementation consists of a private constructor and a field to hold its result, and a static accessor method with a name like getInstance().

The private field can be assigned from within a static initializer block or, more simply, using an initializer. The getInstance() method (which must be public) then simply returns this instance:

```
// File Name: Singleton.java
public class Singleton{

private static Singleton singleton =new Singleton();

/* A private Constructor prevents any other
 * class from instantiating.
 */
private Singleton(){}

/* Static 'instance' method */
public static Singleton getInstance(){
return singleton;
}

/* Other methods protected by singleton-ness */
protected static void demoMethod(){
System.out.println("demoMethod for singleton");
}
}

// File Name: SingletonDemo.java
public lassSingletonDemo{
public staticvoid main(String[] args){
Singleton tmp =Singleton.getInstance();
tmp.demoMethod();
}
}
```

This would produce the following result:

```
demoMethod for singleton
```

Example 2:

Following implementation shows a classic Singleton design pattern:

```
public class ClassicSingleton{  
  
    private static ClassicSingleton instance =null;  
    protected ClassicSingleton(){  
        // Exists only to defeat instantiation.  
    }  
    public static ClassicSingleton getInstance(){  
        if(instance ==null){  
            instance =new ClassicSingleton();  
        }  
        return instance;  
    }  
}
```

The ClassicSingleton class maintains a static reference to the lone singleton instance and returns that reference from the static getInstance() method.

Here ClassicSingleton class employs a technique known as lazy instantiation to create the singleton; as a result, the singleton instance is not created until the getInstance() method is called for the first time. This technique ensures that singleton instances are created only when needed.

Creating an Object:

As mentioned previously, a class provides the blueprints for objects. So basically an object is created from a class. In Java the new keyword is used to create new objects.

There are three steps when creating an object from a class:

- **Declaration:** A variable declaration with a variable name with an object type.
- **Instantiation:** The 'new' keyword is used to create the object.
- **Initialization:** The 'new' keyword is followed by a call to a constructor. This call initializes the new object.

Example of creating an object is given below:

```
public class Puppy{  
  
    public Puppy(String name){  
        // This constructor has one parameter, name.  
        System.out.println("Passed Name is :"+ name );  
    }  
    public static void main(String[]args){  
        // Following statement would create an object myPuppy  
        Puppy myPuppy =new Puppy("tommy");  
    }  
}
```

If we compile and run the above program, then it would produce the following result:

```
PassedNameis:tommy
```

Accessing Instance Variables and Methods:

Instance variables and methods are accessed via created objects. To access an instance variable the fully qualified path should be as follows:

```
/* First create an object */
ObjectReference = new Constructor();

/* Now call a variable as follows */
ObjectReference.variableName;

/* Now you can call a class method as follows */
ObjectReference.MethodName();
```

Example:

This example explains how to access instance variables and methods of a class:

```
public class Puppy{

    int puppyAge;

    public Puppy(String name){
        // This constructor has one parameter, name.
        System.out.println("Passed Name is :"+ name );
    }

    public void setAge(int age ){
        puppyAge = age;
    }

    public int getAge(){
        System.out.println("Puppy's age is :"+ puppyAge );
        return puppyAge;
    }

    public static void main(String[]args){
        /* Object creation */
        Puppy myPuppy =newPuppy("tommy");

        /* Call class method to set puppy's age */
        myPuppy.setAge(2);

        /* Call another class method to get puppy's age */
        myPuppy.getAge();

        /* You can access instance variable as follows as well */
        System.out.println("Variable Value :"+ myPuppy.puppyAge );
    }
}
```

If we compile and run the above program, then it would produce the following result:

```
PassedName is:tommy
Puppy's age is :2
Variable Value :2
```

Source file declaration rules:

As the last part of this section, let's now look into the source file declaration rules. These rules are essential when declaring classes, *import* statements and *package* statements in a source file.

- There can be only one public class per source file.
- A source file can have multiple non public classes.

TUTORIALS POINT

Simply Easy Learning

- The public class name should be the name of the source file as well which should be appended by **.java** at the end. For example : The class name is `.public class Employee{}` Then the source file should be as `Employee.java`.
- If the class is defined inside a package, then the package statement should be the first statement in the source file.
- If import statements are present then they must be written between the package statement and the class declaration. If there are no package statements then the import statement should be the first line in the source file.
- Import and package statements will imply to all the classes present in the source file. It is not possible to declare different import and/or package statements to different classes in the source file.

Classes have several access levels and there are different types of classes; abstract classes, final classes, etc. I will be explaining about all these in the access modifiers chapter.

Apart from the above mentioned types of classes, Java also has some special classes called Inner classes and Anonymous classes.

Java Package:

In simple, it is a way of categorizing the classes and interfaces. When developing applications in Java, hundreds of classes and interfaces will be written, therefore categorizing these classes is a must as well as makes life much easier.

Import statements:

In Java if a fully qualified name, which includes the package and the class name, is given, then the compiler can easily locate the source code or classes. Import statement is a way of giving the proper location for the compiler to find that particular class.

For example, the following line would ask compiler to load all the classes available in directory `java_installation/java/io`

```
import java.io.*;
```

A Simple Case Study:

For our case study, we will be creating two classes. They are `Employee` and `EmployeeTest`.

First open notepad and add the following code. Remember this is the `Employee` class and the class is a public class. Now, save this source file with the name `Employee.java`.

The `Employee` class has four instance variables name, age, designation and salary. The class has one explicitly defined constructor, which takes a parameter.

```
import java.io.*;
public class Employee{
String name;
int age;
String designation;
double salary;

// This is the constructor of the class Employee
public Employee(String name){
```

TUTORIALS POINT

Simply Easy Learning

```

this.name = name;
}
// Assign the age of the Employee to the variable age.
public void empAge(int empAge){
    age = empAge;
}
/* Assign the designation to the variable designation.*/
public void empDesignation(String empDesig){
    designation = empDesig;
}
/* Assign the salary to the variable salary.*/
public void empSalary(double empSalary){
    salary = empSalary;
}
/* Print the Employee details */
public void printEmployee(){
    System.out.println("Name:"+ name );
    System.out.println("Age:"+ age );
    System.out.println("Designation:"+ designation );
    System.out.println("Salary:"+ salary);
}
}

```

As mentioned previously in this tutorial, processing starts from the main method. Therefore in-order for us to run this Employee class there should be main method and objects should be created. We will be creating a separate class for these tasks.

Given below is the *EmployeeTest* class, which creates two instances of the class Employee and invokes the methods for each object to assign values for each variable.

Save the following code in EmployeeTest.java file

```

import java.io.*;
public class EmployeeTest{

    public static void main(String args[]){
        /* Create two objects using constructor */
        Employee empOne = new Employee("James Smith");
        Employee empTwo = new Employee("Mary Anne");

        // Invoking methods for each object created
        empOne.empAge(26);
        empOne.empDesignation("Senior Software Engineer");
        empOne.empSalary(1000);
        empOne.printEmployee();

        empTwo.empAge(21);
        empTwo.empDesignation("Software Engineer");
        empTwo.empSalary(500);
        empTwo.printEmployee();
    }
}

```

Now, compile both the classes and then run *EmployeeTest* to see the result as follows:

```

C :> javac Employee.java
C :> vi EmployeeTest.java
C :> javac EmployeeTest.java
C :> java EmployeeTest
Name:JamesSmith

```

```
Age:26  
Designation:SeniorSoftwareEngineer  
Salary:1000.0  
Name:MaryAnne  
Age:21  
Designation:SoftwareEngineer  
Salary:500.0
```

What is Next?

Next session will discuss basic data types in Java and how they can be used when developing Java applications.

Java Basic Data Types

Variables are nothing but reserved memory locations to store values. This means that when you create a variable you reserve some space in memory.

Based on the data type of a variable, the operating system allocates memory and decides what can be stored in the reserved memory. Therefore, by assigning different data types to variables, you can store integers, decimals, or characters in these variables.

There are two data types available in Java:

- Primitive Data Types
- Reference/Object Data Types

Primitive Data Types:

There are eight primitive data types supported by Java. Primitive data types are predefined by the language and named by a keyword. Let us now look into detail about the eight primitive data types.

byte:

- Byte data type is an 8-bit signed two's complement integer.
- Minimum value is -128 (-2^7)
- Maximum value is 127 (inclusive) ($2^7 - 1$)
- Default value is 0
- Byte data type is used to save space in large arrays, mainly in place of integers, since a byte is four times smaller than an int.
- Example: byte a = 100, byte b = -50

short:

- Short data type is a 16-bit signed two's complement integer.

TUTORIALS POINT

Simply Easy Learning

- Minimum value is -32,768 (-2^{15})
- Maximum value is 32,767(inclusive) ($2^{15} - 1$)
- Short data type can also be used to save memory as byte data type. A short is 2 times smaller than an int
- Default value is 0.
- Example: short s= 10000, short r = -20000

int:

- int data type is a 32-bit signed two's complement integer.
- Minimum value is - 2,147,483,648. (-2^{31})
- Maximum value is 2,147,483,647(inclusive). ($2^{31} - 1$)
- Int is generally used as the default data type for integral values unless there is a concern about memory.
- The default value is 0.
- Example: int a = 100000, int b = -200000

long:

- Long data type is a 64-bit signed two's complement integer.
- Minimum value is -9,223,372,036,854,775,808. (-2^{63})
- Maximum value is 9,223,372,036,854,775,807 (inclusive). ($2^{63} - 1$)
- This type is used when a wider range than int is needed.
- Default value is 0L.
- Example: int a = 100000L, int b = -200000L

float:

- Float data type is a single-precision 32-bit IEEE 754 floating point.
- Float is mainly used to save memory in large arrays of floating point numbers.
- Default value is 0.0f.
- Float data type is never used for precise values such as currency.
- Example: float f1 = 234.5f

double:

- double data type is a double-precision 64-bit IEEE 754 floating point.
- This data type is generally used as the default data type for decimal values, generally the default choice.
- Double data type should never be used for precise values such as currency.
- Default value is 0.0d.
- Example: double d1 = 123.4

boolean:

- boolean data type represents one bit of information.
- There are only two possible values: true and false.
- This data type is used for simple flags that track true/false conditions.
- Default value is false.
- Example: boolean one = true

char:

- char data type is a single 16-bit Unicode character.
- Minimum value is '\u0000' (or 0).
- Maximum value is '\uffff' (or 65,535 inclusive).
- Char data type is used to store any character.
- Example: char letterA ='A'

Reference Data Types:

- Reference variables are created using defined constructors of the classes. They are used to access objects. These variables are declared to be of a specific type that cannot be changed. For example, Employee, Puppy, etc.
- Class objects and various types of array variables come under reference data type.
- Default value of any reference variable is null.
- A reference variable can be used to refer to any object of the declared type or any compatible type.
- Example: Animal animal = new Animal("giraffe");

Java Literals:

A literal is a source code representation of a fixed value. They are represented directly in the code without any computation.

Literals can be assigned to any primitive type variable. For example:

```
byte a =68;  
char a ='A'
```

byte, int, long, and short can be expressed in decimal(base 10),hexadecimal(base 16) or octal(base 8) number systems as well.

Prefix 0 is used to indicate octal and prefix 0x indicates hexadecimal when using these number systems for literals. For example:

```
int decimal=100;  
int octal =0144;  
int hexa =0x64;
```

String literals in Java are specified like they are in most other languages by enclosing a sequence of characters between a pair of double quotes. Examples of string literals are:

```
"Hello World"  
"two\nlines"  
"\\"This is in quotes\""
```

String and char types of literals can contain any Unicode characters. For example:

```
char a ='\u0001';  
String a ="\u0001";
```

Java language supports few special escape sequences for String and char literals as well. They are:

Notation	Character represented
\n	Newline (0x0a)
\r	Carriage return (0x0d)
\f	Formfeed (0x0c)
\b	Backspace (0x08)
\s	Space (0x20)
\t	Tab
\"	Double quote
\'	Single quote
\\	Backslash
\ddd	Octal character (ddd)
\uxxxx	Hexadecimal UNICODE character (xxxx)

What is Next?

This chapter explained you various data types, next topic explains different variable types and their usage. This will give you a good understanding about how they can be used in the Java classes, interfaces, etc.

Java Variable Types

A variable provides us with named storage that our programs can manipulate. Each variable in Java has a specific type, which determines the size and layout of the variable's memory; the range of values that can be stored within that memory; and the set of operations that can be applied to the variable.

You must declare all variables before they can be used. The basic form of a variable declaration is shown here:

```
data type variable [= value][, variable [= value] ...] ;
```

Here *data type* is one of Java's datatypes and *variable* is the name of the variable. To declare more than one variable of the specified type, you can use a comma-separated list.

Following are valid examples of variable declaration and initialization in Java:

```
int a, b, c;           // Declares three ints, a, b, and c.
int a = 10, b = 10;   // Example of initialization
byte B = 22;          // initializes a byte type variable B.
double pi = 3.14159; // declares and assigns a value of PI.
char a = 'a';         // the char variable a is initialized with value 'a'
```

This chapter will explain various variable types available in Java Language. There are three kinds of variables in Java:

- Local variables
- Instance variables
- Class/static variables

Local variables:

- Local variables are declared in methods, constructors, or blocks.
- Local variables are created when the method, constructor or block is entered and the variable will be destroyed once it exits the method, constructor or block.
- Access modifiers cannot be used for local variables.

- Local variables are visible only within the declared method, constructor or block.
- Local variables are implemented at stack level internally.
- There is no default value for local variables so local variables should be declared and an initial value should be assigned before the first use.

Example:

Here, *age* is a local variable. This is defined inside *pupAge()* method and its scope is limited to this method only.

```
public class Test{
    public void pupAge(){
        int age = 0;
        age = age + 7;
        System.out.println("Puppy age is : " + age);
    }

    public static void main(String args[]){
        Test test = new Test();
        test.pupAge();
    }
}
```

This would produce the following result:

```
Puppy age is: 7
```

Example:

Following example uses *age* without initializing it, so it would give an error at the time of compilation.

```
public class Test{
    public void pupAge(){
        int age;
        age = age + 7;
        System.out.println("Puppy age is : " + age);
    }

    public static void main(String args[]){
        Test test = new Test();
        test.pupAge();
    }
}
```

This would produce the following error while compiling it:

```
Test.java:4:variable number might not have been initialized
age = age + 7;
      ^
1 error
```

Instance variables:

- Instance variables are declared in a class, but outside a method, constructor or any block.

- When a space is allocated for an object in the heap, a slot for each instance variable value is created.
- Instance variables are created when an object is created with the use of the keyword 'new' and destroyed when the object is destroyed.
- Instance variables hold values that must be referenced by more than one method, constructor or block, or essential parts of an object's state that must be present throughout the class.
- Instance variables can be declared in class level before or after use.
- Access modifiers can be given for instance variables.
- The instance variables are visible for all methods, constructors and block in the class. Normally, it is recommended to make these variables private (access level). However visibility for subclasses can be given for these variables with the use of access modifiers.
- Instance variables have default values. For numbers the default value is 0, for Booleans it is false and for object references it is null. Values can be assigned during the declaration or within the constructor.
- Instance variables can be accessed directly by calling the variable name inside the class. However within static methods and different class (when instance variables are given accessibility) should be called using the fully qualified name . *ObjectReference.VariableName*.

Example:

```
import java.io.*;

public class Employee{
    // this instance variable is visible for any child class.
    public String name;

    // salary variable is visible in Employee class only.
    private double salary;

    // The name variable is assigned in the constructor.
    public Employee (String empName){
        name = empName;
    }

    // The salary variable is assigned a value.
    public void setSalary(double empSal){
        salary = empSal;
    }

    // This method prints the employee details.
    public void printEmp(){
        System.out.println("name : " + name );
        System.out.println("salary :"+ salary);
    }

    public static void main(String args[]){
        Employee empOne = new Employee("Ransika");
        empOne.setSalary(1000);
        empOne.printEmp();
    }
}
```

This would produce the following result:

```
name : Ransika
salary :1000.0
```

Class/static variables:

- Class variables also known as static variables are declared with the *static* keyword in a class, but outside a method, constructor or a block.
- There would only be one copy of each class variable per class, regardless of how many objects are created from it.
- Static variables are rarely used other than being declared as constants. Constants are variables that are declared as public/private, final and static. Constant variables never change from their initial value.
- Static variables are stored in static memory. It is rare to use static variables other than declared final and used as either public or private constants.
- Static variables are created when the program starts and destroyed when the program stops.
- Visibility is similar to instance variables. However, most static variables are declared public since they must be available for users of the class.
- Default values are same as instance variables. For numbers, the default value is 0; for Booleans, it is false; and for object references, it is null. Values can be assigned during the declaration or within the constructor. Additionally values can be assigned in special static initializer blocks.
- Static variables can be accessed by calling with the class name . *ClassName.VariableName*.
- When declaring class variables as public static final, then variables names (constants) are all in upper case. If the static variables are not public and final the naming syntax is the same as instance and local variables.

Example:

```
import java.io.*;

public class Employee{
    // salary variable is a private static variable
    private static double salary;

    // DEPARTMENT is a constant
    public static final String DEPARTMENT = "Development ";

    public static void main(String args[]){
        salary = 1000;
        System.out.println(DEPARTMENT+"average salary:"+salary);
    }
}
```

This would produce the following result:

```
Development average salary:1000
```

Note: If the variables are access from an outside class the constant should be accessed as Employee.DEPARTMENT

What is Next?

You already have used access modifiers (public & private) in this chapter. The next chapter will explain you Access Modifiers and Non Access Modifiers in detail.

Java Modifier Types

Modifiers are keywords that you add to those definitions to change their meanings. The Java language has a wide variety of modifiers, including the following:

1. Java Access Modifiers

Java provides a number of access modifiers to set access levels for classes, variables, methods and constructors. The four access levels are:

- Visible to the package, the default. No modifiers are needed.
- Visible to the class only (private).
- Visible to the world (public).
- Visible to the package and all subclasses (protected).

Default Access Modifier - No keyword:

Default access modifier means we do not explicitly declare an access modifier for a class, field, method, etc.

A variable or method declared without any access control modifier is available to any other class in the same package. The fields in an interface are implicitly public static final and the methods in an interface are by default public

Example:

Variables and methods can be declared without any modifiers, as in the following examples:

```
String version ="1.5.1";

boolean processOrder(){
return true;
}
```

Private Access Modifier - private:

Methods, Variables and Constructors that are declared private can only be accessed within the declared class itself.

Private access modifier is the most restrictive access level. Class and interfaces cannot be private.

Variables that are declared private can be accessed outside the class if public getter methods are present in the class.

Using the private modifier is the main way that an object encapsulates itself and hide data from the outside world.

Example:

The following class uses private access control:

```
public class Logger{
    private String format;
    public String getFormat(){
        return this.format;
    }
    public void setFormat(String format){
        this.format = format;
    }
}
```

Here, the *format* variable of the *Logger* class is private, so there's no way for other classes to retrieve or set its value directly.

So to make this variable available to the outside world, we defined two public methods: *getFormat()*, which returns the value of *format*, and *setFormat(String)*, which sets its value.

Public Access Modifier - public:

A class, method, constructor, interface etc declared public can be accessed from any other class. Therefore fields, methods, blocks declared inside a public class can be accessed from any class belonging to the Java Universe.

However if the public class we are trying to access is in a different package, then the public class still need to be imported.

Because of class inheritance, all public methods and variables of a class are inherited by its subclasses.

Example:

The following function uses public access control:

```
public static void main(String[] arguments){
    // ...
}
```

The *main()* method of an application has to be public. Otherwise, it could not be called by a Java interpreter (such as *java*) to run the class.

Protected Access Modifier - protected:

Variables, methods and constructors which are declared protected in a superclass can be accessed only by the subclasses in other package or any class within the package of the protected members' class.

The protected access modifier cannot be applied to class and interfaces. Methods, fields can be declared protected, however methods and fields in an interface cannot be declared protected.

Protected access gives the subclass a chance to use the helper method or variable, while preventing a nonrelated class from trying to use it.

Example:

The following parent class uses protected access control, to allow its child class override `openSpeaker()` method:

```
class AudioPlayer{
protected boolean openSpeaker(Speaker sp){
// implementation details
}
}

class StreamingAudioPlayer{
boolean openSpeaker(Speaker sp){
// implementation details
}
}
```

Here, if we define `openSpeaker()` method as private, then it would not be accessible from any other class other than `AudioPlayer`. If we define it as public, then it would become accessible to all the outside world. But our intention is to expose this method to its subclass only, that's why we used `protected` modifier.

Access Control and Inheritance:

The following rules for inherited methods are enforced:

- Methods declared public in a superclass also must be public in all subclasses.
- Methods declared protected in a superclass must either be protected or public in subclasses; they cannot be private.
- Methods declared without access control (no modifier was used) can be declared more private in subclasses.
- Methods declared private are not inherited at all, so there is no rule for them.

2. Non Access Modifiers

To use a modifier, you include its keyword in the definition of a class, method, or variable. The modifier precedes the rest of the statement, as in the following examples (Italic ones):

```
public class className {
// ...
}
private boolean myFlag;
static final double weeks =9.5;
protected static final int BOXWIDTH =42;
public static void main(String[] arguments){
```

TUTORIALS POINT

Simply Easy Learning

```
// body of method
}
```

Access Control Modifiers:

Java provides a number of access modifiers to set access levels for classes, variables, methods and constructors. The four access levels are:

- Visible to the package. the default. No modifiers are needed.
- Visible to the class only (private).
- Visible to the world (public).
- Visible to the package and all subclasses (protected).

Non Access Modifiers:

Java provides a number of non-access modifiers to achieve many other functionality.

- The *static* modifier for creating class methods and variables
- The *final* modifier for finalizing the implementations of classes, methods, and variables.
- The *abstract* modifier for creating abstract classes and methods.
- The *synchronized* and *volatile* modifiers, which are used for threads.

To use a modifier, you include its keyword in the definition of a class, method, or variable. The modifier precedes the rest of the statement, as in the following examples (Italic ones):

```
public class className {
// ...
}
private boolean myFlag;
static final double weeks =9.5;
protected static final int BOXWIDTH =42;
public static void main(String[] arguments){
// body of method
}
```

Access Control Modifiers:

Java provides a number of access modifiers to set access levels for classes, variables, methods and constructors. The four access levels are:

- Visible to the package. the default. No modifiers are needed.
- Visible to the class only (private).
- Visible to the world (public).
- Visible to the package and all subclasses (protected).

Non Access Modifiers:

Java provides a number of non-access modifiers to achieve many other functionality.

- The *static* modifier for creating class methods and variables
- The *final* modifier for finalizing the implementations of classes, methods, and variables.
- The *abstract* modifier for creating abstract classes and methods.
- The *synchronized* and *volatile* modifiers, which are used for threads.

What is Next?

In the next section, I will be discussing about Basic Operators used in the Java Language. The chapter will give you an overview of how these operators can be used during application development.

Java Basic Operators

Java provides a rich set of operators to manipulate variables. We can divide all the Java operators into the following groups:

- Arithmetic Operators
- Relational Operators
- Bitwise Operators
- Logical Operators
- Assignment Operators
- Misc Operators

The Arithmetic Operators:

Arithmetic operators are used in mathematical expressions in the same way that they are used in algebra. The following table lists the arithmetic operators:

Assume integer variable A holds 10 and variable B holds 20, then:

Operator	Description	Example
+	Addition - Adds values on either side of the operator	A + B will give 30
-	Subtraction - Subtracts right hand operand from left hand operand	A - B will give -10
*	Multiplication - Multiplies values on either side of the operator	A * B will give 200
/	Division - Divides left hand operand by right hand operand	B / A will give 2
%	Modulus - Divides left hand operand by right hand operand and returns remainder	B % A will give 0
++	Increment - Increases the value of operand by 1	B++ gives 21
--	Decrement - Decreases the value of operand by 1	B-- gives 19

Example

The following simple example program demonstrates the arithmetic operators. Copy and paste the following Java program in Test.java file and compile and run this program:

```
public class Test{

public static void main(String args[]){
int a =10;
int b =20;
int c =25;
int d =25;
System.out.println("a + b = "+(a + b));
System.out.println("a - b = "+(a - b));
System.out.println("a * b = "+(a * b));
System.out.println("b / a = "+(b / a));
System.out.println("b % a = "+(b % a));
System.out.println("c % a = "+(c % a));
System.out.println("a++ = "+(a++));
System.out.println("b-- = "+(a--));
// Check the difference in d++ and ++d
System.out.println("d++ = "+(d++));
System.out.println("++d = "+(++d));
}
}
```

This would produce the following result:

```
a + b =30
a - b =-10
a * b =200
b / a =2
b % a =0
c % a =5
a++=10
b--=11
d++=25
++d =27
```

The Relational Operators:

There are following relational operators supported by Java language:

Assume variable A holds 10 and variable B holds 20, then:

Operator	Description	Example
==	Checks if the values of two operands are equal or not, if yes then condition becomes true.	(A == B) is not true.
!=	Checks if the values of two operands are equal or not, if values are not equal then condition becomes true.	(A != B) is true.
>	Checks if the value of left operand is greater than the value of right operand, if yes then condition becomes true.	(A > B) is not true.
<	Checks if the value of left operand is less than the value of right operand, if yes then condition becomes true.	(A < B) is true.
>=	Checks if the value of left operand is greater than or equal to the value	(A >= B) is not true.

TUTORIALS POINT

Simply Easy Learning

	of right operand, if yes then condition becomes true.	
<=	Checks if the value of left operand is less than or equal to the value of right operand, if yes then condition becomes true.	(A <= B) is true.

Example

The following simple example program demonstrates the relational operators. Copy and paste the following Java program in Test.java file and compile and run this program. :

```
public class Test{

public static void main(String args[]){
int a =10;
int b =20;
System.out.println("a == b = "+(a == b));
System.out.println("a != b = "+(a != b));
System.out.println("a > b = "+(a > b));
System.out.println("a < b = "+(a < b));
System.out.println("b >= a = "+(b >= a));
System.out.println("b <= a = "+(b <= a));
}
}
```

This would produce the following result:

```
a == b =false
a != b =true
a > b =false
a < b =true
b >= a =true
b <= a =false
```

The Bitwise Operators:

Java defines several bitwise operators, which can be applied to the integer types, long, int, short, char, and byte.

Bitwise operator works on bits and performs bit-by-bit operation. Assume if a = 60; and b = 13; now in binary format they will be as follows:

a = 0011 1100

b = 0000 1101

a&b = 0000 1100

alb = 0011 1101

a^b = 0011 0001

~a = 1100 0011

The following table lists the bitwise operators:

Assume integer variable A holds 60 and variable B holds 13, then:

TUTORIALS POINT

Simply Easy Learning

Operator	Description	Example
&	Binary AND Operator copies a bit to the result if it exists in both operands.	(A & B) will give 12 which is 0000 1100
	Binary OR Operator copies a bit if it exists in either operand.	(A B) will give 61 which is 0011 1101
^	Binary XOR Operator copies the bit if it is set in one operand but not both.	(A ^ B) will give 49 which is 0011 0001
~	Binary Ones Complement Operator is unary and has the effect of 'flipping' bits.	(~A) will give -60 which is 1100 0011
<<	Binary Left Shift Operator. The left operands value is moved left by the number of bits specified by the right operand.	A << 2 will give 240 which is 1111 0000
>>	Binary Right Shift Operator. The left operands value is moved right by the number of bits specified by the right operand.	A >> 2 will give 15 which is 1111
>>>	Shift right zero fill operator. The left operands value is moved right by the number of bits specified by the right operand and shifted values are filled up with zeros.	A >>>2 will give 15 which is 0000 1111

Example

The following simple example program demonstrates the bitwise operators. Copy and paste the following Java program in Test.java file and compile and run this program:

```
public class Test{

    public static void main(String args[]){
        int a =60;          /* 60 = 0011 1100 */
        int b =13;         /* 13 = 0000 1101 */
        int c =0;

        c = a & b; /* 12 = 0000 1100 */
        System.out.println("a & b = "+ c );

        c = a | b; /* 61 = 0011 1101 */
        System.out.println("a | b = "+ c );

        c = a ^ b; /* 49 = 0011 0001 */
        System.out.println("a ^ b = "+ c );

        c =~a; /* -61 = 1100 0011 */
        System.out.println("~a = "+ c );

        c = a <<2; /* 240 = 1111 0000 */
        System.out.println("a << 2 = "+ c );

        c = a >>2; /* 215 = 1111 */
        System.out.println("a >> 2 = "+ c );

        c = a >>>2; /* 215 = 0000 1111 */
        System.out.println("a >>> 2 = "+ c );
    }
}
```

```
}
```

This would produce the following result:

```
a & b =12
a | b =61
a ^ b =49
~a =-61
a <<2=240
a >>15
a >>>15
```

The Logical Operators:

The following table lists the logical operators:

Assume Boolean variables A holds true and variable B holds false, then:

Operator	Description	Example
&&	Called Logical AND operator. If both the operands are non-zero, then the condition becomes true.	(A && B) is false.
	Called Logical OR Operator. If any of the two operands are non-zero, then the condition becomes true.	(A B) is true.
!	Called Logical NOT Operator. Use to reverses the logical state of its operand. If a condition is true then Logical NOT operator will make false.	!(A && B) is true.

Example

The following simple example program demonstrates the logical operators. Copy and paste the following Java program in Test.java file and compile and run this program:

```
public class Test{

    public static void main(String args[]){
        boolean a =true;
        boolean b =false;

        System.out.println("a && b = "+(a&&b));

        System.out.println("a || b = "+(a||b));

        System.out.println("!(a && b) = "+!(a && b));
    }
}
```

This would produce the following result:

```
a && b =false
a || b =true
!(a && b)=true
```

The Assignment Operators:

There are following assignment operators supported by Java language:

Operator	Description	Example
=	Simple assignment operator, Assigns values from right side operands to left side operand	C = A + B will assign value of A + B into C
+=	Add AND assignment operator, It adds right operand to the left operand and assign the result to left operand	C += A is equivalent to C = C + A
-=	Subtract AND assignment operator, It subtracts right operand from the left operand and assign the result to left operand	C -= A is equivalent to C = C - A
*=	Multiply AND assignment operator, It multiplies right operand with the left operand and assign the result to left operand	C *= A is equivalent to C = C * A
/=	Divide AND assignment operator, It divides left operand with the right operand and assign the result to left operand	C /= A is equivalent to C = C / A
%=	Modulus AND assignment operator, It takes modulus using two operands and assign the result to left operand	C %= A is equivalent to C = C % A
<<=	Left shift AND assignment operator	C <<= 2 is same as C = C << 2
>>=	Right shift AND assignment operator	C >>= 2 is same as C = C >> 2
&=	Bitwise AND assignment operator	C &= 2 is same as C = C & 2
^=	bitwise exclusive OR and assignment operator	C ^= 2 is same as C = C ^ 2
=	bitwise inclusive OR and assignment operator	C = 2 is same as C = C 2

Example:

The following simple example program demonstrates the assignment operators. Copy and paste the following Java program in Test.java file and compile and run this program:

```
public class Test{

public static void main(String args[]){
int a =10;
int b =20;
int c =0;

    c = a + b;
System.out.println("c = a + b = "+ c );

    c += a ;
System.out.println("c += a = "+ c );

    c -= a ;
System.out.println("c -= a = "+ c );

    c *= a ;
System.out.println("c *= a = "+ c );

    a =10;
    c =15;
}
```

```

    c /= a ;
    System.out.println("c /= a = "+ c );

    a =10;
    c =15;
    c %= a ;
    System.out.println("c %= a = "+ c );

    c <<=2;
    System.out.println("c <<= 2 = "+ c );

    c >>=2;
    System.out.println("c >>= 2 = "+ c );

    c >>=2;
    System.out.println("c >>= a = "+ c );

    c &= a ;
    System.out.println("c &= 2 = "+ c );

    c ^= a ;
    System.out.println("c ^= a = "+ c );

    c |= a ;
    System.out.println("c |= a = "+ c );
}
}

```

This would produce the following result:

```

c = a + b =30
c += a =40
c -= a =30
c *= a =300
c /= a =1
c %= a =5
c <<=2=20
c >>=2=5
c >>=2=1
c &= a =0
c ^= a =10
c |= a =10

```

Misc Operators

There are few other operators supported by Java Language.

Conditional Operator (?):

Conditional operator is also known as the ternary operator. This operator consists of three operands and is used to evaluate Boolean expressions. The goal of the operator is to decide which value should be assigned to the variable. The operator is written as:

```
variable x =(expression)? value iftrue: value iffalse
```

Following is the example:

```
public class Test{
```

TUTORIALS POINT

Simply Easy Learning

```

public static void main(String args[]){
int a , b;
a =10;
b =(a ==1)?20:30;
System.out.println("Value of b is : "+ b );

b =(a ==10)?20:30;
System.out.println("Value of b is : "+ b );
}
}

```

This would produce the following result:

```

Value of b is:30
Value of b is:20

```

instanceof Operator:

This operator is used only for object reference variables. The operator checks whether the object is of a particular type(class type or interface type). instanceof operator is written as:

```

(Object reference variable ) instanceof (class/interface type)

```

If the object referred by the variable on the left side of the operator passes the IS-A check for the class/interface type on the right side, then the result will be true. Following is the example:

```

String name = "James";
boolean result = name instanceof String;
// This will return true since name is type of String

```

This operator will still return true if the object being compared is the assignment compatible with the type on the right. Following is one more example:

```

class Vehicle{}

public class CarextendsVehicle{
public static void main(String args[]){
Vehicle a =newCar();
boolean result = a instanceofCar;
System.out.println(result);
}
}

```

This would produce the following result:

```

true

```

Precedence of Java Operators:

Operator precedence determines the grouping of terms in an expression. This affects how an expression is evaluated. Certain operators have higher precedence than others; for example, the multiplication operator has higher precedence than the addition operator:

For example, $x = 7 + 3 * 2$; here, x is assigned 13, not 20 because operator $*$ has higher precedence than $+$, so it first gets multiplied with $3*2$ and then adds into 7.

Here, operators with the highest precedence appear at the top of the table, those with the lowest appear at the bottom. Within an expression, higher precedence operators will be evaluated first.

Category	Operator	Associativity
Postfix	() [] . (dot operator)	Left to right
Unary	++ -- ! ~	Right to left
Multiplicative	* / %	Left to right
Additive	+ -	Left to right
Shift	>>>><<<<	Left to right
Relational	>>= <<=	Left to right
Equality	== !=	Left to right
Bitwise AND	&	Left to right
Bitwise XOR	^	Left to right
Bitwise OR		Left to right
Logical AND	&&	Left to right
Logical OR		Left to right
Conditional	?:	Right to left
Assignment	= += -= *= /= %= >>= <<= &= ^= =	Right to left
Comma	,	Left to right

What is Next?

Next chapter would explain about loop control in Java programming. The chapter will describe various types of loops and how these loops can be used in Java program development and for what purposes they are being used.

Java Loop Control

There may be a situation when we need to execute a block of code several number of times and is often referred to as a loop.

Java has very flexible three looping mechanisms. You can use one of the following three loops:

- while Loop
- do...while Loop
- for Loop

As of Java 5, the *enhanced for loop* was introduced. This is mainly used for Arrays.

The while Loop:

A while loop is a control structure that allows you to repeat a task a certain number of times.

Syntax:

The syntax of a while loop is:

```
while(Boolean_expression)
{
  //Statements
}
```

When executing, if the *boolean_expression* result is true, then the actions inside the loop will be executed. This will continue as long as the expression result is true.

Here, key point of the *while* loop is that the loop might not ever run. When the expression is tested and the result is false, the loop body will be skipped and the first statement after the while loop will be executed.

Example:

```
public class Test{
    public static void main(String args[]){
        int x =10;
        while( x <20){
```

```
System.out.print("value of x : "+ x );
    x++;
System.out.print("\n");
}
}
}
```

This would produce the following result:

```
value of x :10
value of x :11
value of x :12
value of x :13
value of x :14
value of x :15
value of x :16
value of x :17
value of x :18
value of x :19
```

The do...while Loop:

A do...while loop is similar to a while loop, except that a do...while loop is guaranteed to execute at least one time.

Syntax:

The syntax of a do...while loop is:

```
do
{
//Statements
}while(Boolean_expression);
```

Notice that the Boolean expression appears at the end of the loop, so the statements in the loop execute once before the Boolean is tested.

If the Boolean expression is true, the flow of control jumps back up to do, and the statements in the loop execute again. This process repeats until the Boolean expression is false.

Example:

```
public class Test{

public static void main(String args[]){
int x =10;

do{
System.out.print("value of x : "+ x );
    x++;
System.out.print("\n");
}while( x <20);
}
}
```

This would produce the following result:

```
value of x :10
value of x :11
value of x :12
```

```
value of x :13
value of x :14
value of x :15
value of x :16
value of x :17
value of x :18
value of x :19
```

The for Loop:

A for loop is a repetition control structure that allows you to efficiently write a loop that needs to execute a specific number of times.

A for loop is useful when you know how many times a task is to be repeated.

Syntax:

The syntax of a for loop is:

```
for(initialization; Boolean_expression; update)
{
//Statements
}
```

Here is the flow of control in a for loop:

- The initialization step is executed first, and only once. This step allows you to declare and initialize any loop control variables. You are not required to put a statement here, as long as a semicolon appears.
- Next, the Boolean expression is evaluated. If it is true, the body of the loop is executed. If it is false, the body of the loop does not execute and flow of control jumps to the next statement past the for loop.
- After the body of the for loop executes, the flow of control jumps back up to the update statement. This statement allows you to update any loop control variables. This statement can be left blank, as long as a semicolon appears after the Boolean expression.
- The Boolean expression is now evaluated again. If it is true, the loop executes and the process repeats itself (body of loop, then update step, then Boolean expression). After the Boolean expression is false, the for loop terminates.

Example:

```
public class Test{
public static void main(String args[]){
for(int x =10; x <20; x = x+1){
System.out.print("value of x : "+ x );
System.out.print("\n");
}
}
}
```

This would produce the following result:

```
value of x :10
value of x :11
value of x :12
```

```
value of x :13
value of x :14
value of x :15
value of x :16
value of x :17
value of x :18
value of x :19
```

Enhanced for loop in Java:

As of Java 5, the enhanced for loop was introduced. This is mainly used for Arrays.

Syntax:

The syntax of enhanced for loop is:

```
for(declaration : expression)
{
//Statements
}
```

- **Declaration:** The newly declared block variable, which is of a type compatible with the elements of the array you are accessing. The variable will be available within the for block and its value would be the same as the current array element.
- **Expression:** This evaluates to the array you need to loop through. The expression can be an array variable or method call that returns an array.

Example:

```
public class Test{

public static void main(String args[]){
int[] numbers = {10,20,30,40,50};

for(int x : numbers ){
System.out.print(x);
System.out.print(",");
}
System.out.print("\n");
String[] names = {"James","Larry","Tom","Lacy"};
for(String name : names ){
System.out.print( name );
System.out.print(",");
}
}
}
```

This would produce the following result:

```
10,20,30,40,50,
James,Larry,Tom,Lacy,
```

The break Keyword:

The *break* keyword is used to stop the entire loop. The break keyword must be used inside any loop or a switch statement.

The break keyword will stop the execution of the innermost loop and start executing the next line of code after the block.

Syntax:

The syntax of a break is a single statement inside any loop:

```
break;
```

Example:

```
public class Test{

public static void main(String args[]){
int[] numbers = {10,20,30,40,50};

for(int x : numbers){
if(x ==30){
    break;
}
System.out.print( x );
System.out.print("\n");
}
}
}
```

This would produce the following result:

```
10
20
```

The continue Keyword:

The *continue* keyword can be used in any of the loop control structures. It causes the loop to immediately jump to the next iteration of the loop.

- In a for loop, the continue keyword causes flow of control to immediately jump to the update statement.
- In a while loop or do/while loop, flow of control immediately jumps to the Boolean expression.

Syntax:

The syntax of a continue is a single statement inside any loop:

```
continue;
```

Example:

```
public class Test{

public static void main(String args[]){
int[] numbers = {10,20,30,40,50};

for(int x : numbers){
if( x ==30){
    continue;
}
System.out.print( x );
}
```

```
System.out.print("\n");  
}  
}  
}
```

This would produce the following result:

```
10  
20  
40  
50
```

What is Next?

In the following chapter, we will be learning about decision making statements in Java programming.

Java Decision Making

There are two types of decision making statements in Java. They are:

- if statements
- switch statements

The if Statement:

An if statement consists of a Boolean expression followed by one or more statements.

Syntax:

The syntax of an if statement is:

```
if(Boolean_expression)
{
//Statements will execute if the Boolean expression is true
}
```

If the Boolean expression evaluates to true, then the block of code inside the if statement will be executed. If not, the first set of code after the end of the if statement(after the closing curly brace) will be executed.

Example:

```
public class Test{
public static void main(String args[]){
int x =10;
if( x <20){
System.out.print("This is if statement");
}
}
}
```

This would produce the following result:

```
Thisisif statement
```

The if...else Statement:

An if statement can be followed by an optional *else* statement, which executes when the Boolean expression is false.

Syntax:

The syntax of an if...else is:

```
if(Boolean_expression){
//Executes when the Boolean expression is true
}else{
//Executes when the Boolean expression is false
}
```

Example:

```
public class Test{

public static void main(String args[]){
int x =30;

if(x <20){
System.out.print("This is if statement");
}else{
System.out.print("This is else statement");
}
}
}
```

This would produce the following result:

```
This is else statement
```

The if...else if...else Statement:

An if statement can be followed by an optional *else if...else* statement, which is very useful to test various conditions using single if...else if statement.

When using if, else if , else statements there are few points to keep in mind.

- An if can have zero or one else's and it must come after any else if's.
- An if can have zero to many else if's and they must come before the else.
- Once an else if succeeds, none of the remaining else if's or else's will be tested.

Syntax:

The syntax of an if...else is:

```
if(Boolean_expression1){
//Executes when the Boolean expression 1 is true
}elseif(Boolean_expression2){
//Executes when the Boolean expression 2 is true
}elseif(Boolean_expression3){
//Executes when the Boolean expression 3 is true
}
```



```
}else{
//Executes when the none of the above condition is true.
}
```

Example:

```
public class Test{

public static void main(String args[]){
int x =30;

if( x ==10){
System.out.print("Value of X is 10");
}elseif( x ==20){
System.out.print("Value of X is 20");
}elseif( x ==30){
System.out.print("Value of X is 30");
}else{
System.out.print("This is else statement");
}
}
}
```

This would produce the following result:

```
Value of X is30
```

Nested if...else Statement:

It is always legal to nest if-else statements which means you can use one if or else if statement inside another if or else if statement.

Syntax:

The syntax for a nested if...else is as follows:

```
if(Boolean_expression1){
//Executes when the Boolean expression 1 is true
if(Boolean_expression2){
//Executes when the Boolean expression 2 is true
}
}
```

You can nest *else if...else* in the similar way as we have nested *if* statement.

Example:

```
public class Test{

public static void main(String args[]){
int x =30;
int y =10;

if( x ==30){
if( y ==10){
System.out.print("X = 30 and Y = 10");
}
}
}
```

```
}
```

This would produce the following result:

```
X =30and Y =10
```

The switch Statement:

A *switch* statement allows a variable to be tested for equality against a list of values. Each value is called a case, and the variable being switched on is checked for each case.

Syntax:

The syntax of enhanced for loop is:

```
switch(expression){  
  case value :  
    //Statements  
    break;//optional  
  case value :  
    //Statements  
    break;//optional  
    //You can have any number of case statements.  
  default://Optional  
    //Statements  
}
```

The following rules apply to a switch statement:

- The variable used in a switch statement can only be a byte, short, int, or char.
- You can have any number of case statements within a switch. Each case is followed by the value to be compared to and a colon.
- The value for a case must be the same data type as the variable in the switch and it must be a constant or a literal.
- When the variable being switched on is equal to a case, the statements following that case will execute until a *break* statement is reached.
- When a *break* statement is reached, the switch terminates, and the flow of control jumps to the next line following the switch statement.
- Not every case needs to contain a break. If no break appears, the flow of control will *fall through* to subsequent cases until a break is reached.
- A *switch* statement can have an optional default case, which must appear at the end of the switch. The default case can be used for performing a task when none of the cases is true. No break is needed in the default case.

Example:

```
public class Test{  
  
  public static void main(String args[]){  
    char grade = args[0].charAt(0);  
  
    switch(grade)
```

TUTORIALS POINT

Simply Easy Learning

```

{
case'A':
System.out.println("Excellent!");
break;
case'B':
case'C':
System.out.println("Well done");
break;
case'D':
System.out.println("You passed");
case'F':
System.out.println("Better try again");
break;
default:
System.out.println("Invalid grade");
}
System.out.println("Your grade is "+ grade);
}
}

```

Compile and run above program using various command line arguments. This would produce the following result:

```

$ java Test a
Invalid grade
Your grade is a a
$ java Test A
Excellent!
Your grade is a A
$ java Test C
Welldone
Your grade is a C
$

```

What is Next?

Next chapter discusses about the Number class (in the java.lang package) and its subclasses in Java Language.

We will be looking into some of the situations where you would use instantiations of these classes rather than the primitive data types, as well as classes such as formatting, mathematical functions that you need to know about when working with Numbers.

Java Numbers

Normally, when we work with Numbers, we use primitive data types such as byte, int, long, double, etc.

Example:

```
int i =5000;
float gpa =13.65;
byte mask =0xaf;
```

However, in development, we come across situations where we need to use objects instead of primitive data types. In-order to achieve this, Java provides wrapper classes for each primitive data type.

All the wrapper classes (Integer, Long, Byte, Double, Float, Short) are subclasses of the abstract class Number.

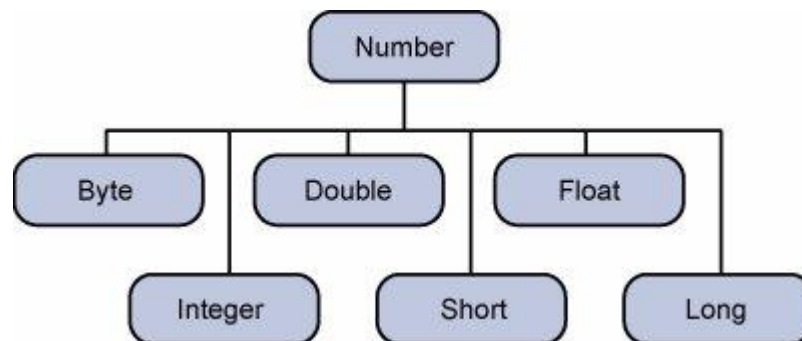

This wrapping is taken care of by the compiler, the process is called boxing. So when a primitive is used when an object is required, the compiler boxes the primitive type in its wrapper class. Similarly, the compiler unboxes the object to a primitive as well. The **Number** is part of the java.lang package.

Here is an example of boxing and unboxing:

```
public class Test{
    public static void main(String args[]){
        Integer x =5;// boxes int to an Integer object
        x = x +10;// unboxes the Integer to a int
        System.out.println(x);
    }
}
```

This would produce the following result:

15

When x is assigned integer values, the compiler boxes the integer because x is integer objects. Later, x is unboxed so that they can be added as integers.

Number Methods:

Here is the list of the instance methods that all the subclasses of the Number class implement:

SN	Methods with Description
1	<u>xxxValue()</u> Converts the value of <i>this</i> Number object to the xxx data type and returned it.
2	<u>compareTo()</u> Compares <i>this</i> Number object to the argument.
3	<u>equals()</u> Determines whether <i>this</i> number object is equal to the argument.
4	<u>valueOf()</u> Returns an Integer object holding the value of the specified primitive.
5	<u>toString()</u> Returns a String object representing the value of specified int or Integer.
6	<u>parseInt()</u> This method is used to get the primitive data type of a certain String.
7	<u>abs()</u> Returns the absolute value of the argument.
8	<u>ceil()</u> Returns the smallest integer that is greater than or equal to the argument. Returned as a double.
9	<u>floor()</u> Returns the largest integer that is less than or equal to the argument. Returned as a double.
10	<u>rint()</u> Returns the integer that is closest in value to the argument. Returned as a double.
11	<u>round()</u> Returns the closest long or int, as indicated by the method's return type, to the argument.
12	<u>min()</u> Returns the smaller of the two arguments.
13	<u>max()</u> Returns the larger of the two arguments.
14	<u>exp()</u> Returns the base of the natural logarithms, e, to the power of the argument.
15	<u>log()</u> Returns the natural logarithm of the argument.
16	<u>pow()</u> Returns the value of the first argument raised to the power of the second argument.

17	<u>sqrt()</u> Returns the square root of the argument.
18	<u>sin()</u> Returns the sine of the specified double value.
19	<u>cos()</u> Returns the cosine of the specified double value.
20	<u>tan()</u> Returns the tangent of the specified double value.
21	<u>asin()</u> Returns the arcsine of the specified double value.
22	<u>acos()</u> Returns the arccosine of the specified double value.
23	<u>atan()</u> Returns the arctangent of the specified double value.
24	<u>atan2()</u> Converts rectangular coordinates (x, y) to polar coordinate (r, theta) and returns theta.
25	<u>toDegrees()</u> Converts the argument to degrees
26	<u>toRadians()</u> Converts the argument to radians.
27	<u>random()</u> Returns a random number.

xxxValue()

Description:

The method converts the value of the Number Object that invokes the method to the primitive data type that is returned from the method.

Syntax:

Here is a separate method for each primitive data type:

```
byte byteValue ()
short shortValue ()
int intValue ()
long longValue ()
float floatValue ()
double doubleValue ()
```

Parameters:

Here is the detail of parameters:

- NA

Return Value:

- These method returns the primitive data type that is given in the signature.

Example:

```
public class Test{

public static void main(String args[]){
Integer x =5;
// Returns byte primitive data type
System.out.println( x.byteValue());

// Returns double primitive data type
System.out.println(x.doubleValue());

// Returns long primitive data type
System.out.println( x.longValue());
}
}
```

This produces the following result:

```
5
5.0
5
```

compareTo()

Description:

The method compares the Number object that invoked the method to the argument. It is possible to compare Byte, Long, Integer, etc.

However, two different types cannot be compared, both the argument and the Number object invoking the method should be of same type.

Syntax:

```
public int compareTo(NumberSubClass referenceName )
```

Parameters:

Here is the detail of parameters:

- **referenceName** -- This could be a Byte, Double, Integer, Float, Long or Short.

Return Value:

- If the Integer is equal to the argument then 0 is returned.
- If the Integer is less than the argument then -1 is returned.

- If the Integer is greater than the argument then 1 is returned.

Example:

```
public class Test{  
  
    public static void main(String args[]){  
        Integer x =5;  
        System.out.println(x.compareTo(3));  
        System.out.println(x.compareTo(5));  
        System.out.println(x.compareTo(8));  
    }  
}
```

This produces the following result:

```
1  
0  
-1
```

equals()

Description:

The method determines whether the Number Object that invokes the method is equal to the argument.

Syntax:

```
public boolean equals(Object o)
```

Parameters:

Here is the detail of parameters:

- o -- Any object.

Return Value:

- The methods returns True if the argument is not null and is an object of the same type and with the same numeric value. There are some extra requirements for Double and Float objects that are described in the Java API documentation.

Example:

```
public class Test{  
  
    public static void main(String args[]){  
        Integer x =5;  
        Integer y =10;  
        Integer z =5;  
        Short a =5;
```



```
System.out.println(x.equals(y));
System.out.println(x.equals(z));
System.out.println(x.equals(a));
}
}
```

This produces the following result:

```
false
true
false
```

valueOf()

Description:

The valueOf method returns the relevant Number Object holding the value of the argument passed. The argument can be a primitive data type, String, etc.

This method is a static method. The method can take two arguments, where one is a String and the other is a radix.

Syntax:

All the variants of this method are given below:

```
staticInteger valueOf(int i)
staticInteger valueOf(String s)
staticInteger valueOf(String s,int radix)
```

Parameters:

Here is the detail of parameters:

- **i** -- An int for which Integer representation would be returned.
- **s** -- A String for which Integer representation would be returned.
- **radix** -- This would be used to decide the value of returned Integer based on passed String.

Return Value:

- **valueOf(int i)**: This returns an Integer object holding the value of the specified primitive.
- **valueOf(String s)**: This returns an Integer object holding the value of the specified string representation.
- **valueOf(String s, int radix)**: This returns an Integer object holding the integer value of the specified string representation, parsed with the value of radix.

```
public class Test{
public static void main(String args[]){
Integer x =Integer.valueOf(9);
}
```

```
Double c =Double.valueOf(5);
Float a =Float.valueOf("80");

Integer b =Integer.valueOf("444",16);

System.out.println(x);
System.out.println(c);
System.out.println(a);
System.out.println(b);
}
}
```

This produces the following result:

```
9
5.0
80.0
1092
```

toString()

Description:

The method is used to get a String object representing the value of the Number Object.

If the method takes a primitive data type as an argument, then the String object representing the primitive data type value is return.

If the method takes two arguments, then a String representation of the first argument in the radix specified by the second argument will be returned.

Syntax:

All the variant of this method are given below:

```
String toString()
staticString toString(int i)
```

Parameters:

Here is the detail of parameters:

- **i** -- An int for which string representation would be returned.

Return Value:

- **toString():** This returns a String object representing the value of **this** Integer.
- **toString(int i):** This returns a String object representing the specified integer.

Example:

```
public class Test{
```

```
public static void main(String args[]){
    Integer x =5;

    System.out.println(x.toString());
    System.out.println(Integer.toString(12));
}
}
```

This produces the following result:

```
5
12
```

parseInt()

Description:

This method is used to get the primitive data type of a certain String. `parseXxx()` is a static method and can have one argument or two.

Syntax:

All the variant of this method are given below:

```
static int parseInt(String s)
static int parseInt(String s, int radix)
```

Parameters:

Here is the detail of parameters:

- **s** -- This is a string representation of decimal.
- **radix** -- This would be used to convert String s into integer.

Return Value:

- **parseInt(String s)**: This returns an integer (decimal only).
- **parseInt(int i)**: This returns an integer, given a string representation of decimal, binary, octal, or hexadecimal (radix equals 10, 2, 8, or 16 respectively) numbers as input.

Example:

```
public class Test{

    public static void main(String args[]){
        int x =Integer.parseInt("9");
        double c =Double.parseDouble("5");
        int b =Integer.parseInt("444",16);

        System.out.println(x);
    }
}
```

```
System.out.println(c);
System.out.println(b);
}
}
```

This produces the following result:

```
9
5.0
1092
```

abs()

Description:

The method gives the absolute value of the argument. The argument can be int, float, long, double, short, byte.

Syntax:

All the variant of this method are given below:

```
double abs(double d)
float abs(float f)
int abs(int i)
long abs(long lng)
```

Parameters:

Here is the detail of parameters:

- Any primitive data type

Return Value:

- This method Returns the absolute value of the argument.

Example:

```
public class Test{

public static void main(String args[]){
Integer a ==-8;
double d ==-100;
float f ==-90;

System.out.println(Math.abs(a));
System.out.println(Math.abs(d));
System.out.println(Math.abs(f));
}
}
```

This produces the following result:

```
8
100.0
90.0
```

ceil()

Description:

The method ceil gives the smallest integer that is greater than or equal to the argument.

Syntax:

This method has following variants:

```
double ceil(double d)
double ceil(float f)
```

Parameters:

Here is the detail of parameters:

- A double or float primitive data type

Return Value:

- This method Returns the smallest integer that is greater than or equal to the argument. Returned as a double.

Example:

```
public class Test{

public static void main(String args[]){
double d =-100.675;
float f =-90;

System.out.println(Math.ceil(d));
System.out.println(Math.ceil(f));

System.out.println(Math.floor(d));
System.out.println(Math.floor(f));
}
}
```

This produces the following result:

```
-100.0
-90.0
-101.0
```

```
-90.0
```

floor()

Description:

The method floor gives the largest integer that is less than or equal to the argument.

Syntax:

This method has following variants:

```
double floor(double d)
double floor(float f)
```

Parameters:

Here is the detail of parameters:

- A double or float primitive data type

Return Value:

- This method Returns the largest integer that is less than or equal to the argument. Returned as a double.

Example:

```
public class Test{
    public static void main(String args[]){
        double d =-100.675;
        float f =-90;

        System.out.println(Math.floor(d));
        System.out.println(Math.floor(f));

        System.out.println(Math.ceil(d));
        System.out.println(Math.ceil(f));
    }
}
```

This produces the following result:

```
-101.0
-90.0
-100.0
-90.0
```

rint()

Description:

The method rint returns the integer that is closest in value to the argument.

Syntax:

```
double rint(double d)
```

Parameters:

Here is the detail of parameters:

- **d** -- A double primitive data type

Return Value:

- This method Returns the integer that is closest in value to the argument. Returned as a double.

Example:

```
public class Test{  
  
    public static void main(String args[]){  
        double d =100.675;  
        double e =100.500;  
        double f =100.200;  
  
        System.out.println(Math.rint(d));  
        System.out.println(Math.rint(e));  
        System.out.println(Math.rint(f));  
    }  
}
```

This produces the following result:

```
101.0  
100.0  
100.0
```

round()

Description:

The method round returns the closest long or int, as given by the methods return type.

Syntax:

This method has following variants:

```
long round(double d)
int round(float f)
```

Parameters:

Here is the detail of parameters:

- **d** -- A double or float primitive data type
- **f** -- A float primitive data type

Return Value:

- This method Returns the closest long or int, as indicated by the method's return type, to the argument.

Example:

```
public class Test{
    public static void main(String args[]){
        double d =100.675;
        double e =100.500;
        float f =100;
        float g =90f;

        System.out.println(Math.round(d));
        System.out.println(Math.round(e));
        System.out.println(Math.round(f));
        System.out.println(Math.round(g));
    }
}
```

This produces the following result:

```
101
101
100
90
```

min()

Description:

The method gives the smaller of the two arguments. The argument can be int, float, long, double.

Syntax:

This method has following variants:

```
double min(double arg1,double arg2)
float min(float arg1,float arg2)
int min(int arg1,int arg2)
long min(long arg1,long arg2)
```

Parameters:

Here is the detail of parameters:

- A primitive data types

Return Value:

- This method Returns the smaller of the two arguments.

Example:

```
public class Test{

public static void main(String args[]){
System.out.println(Math.min(12.123,12.456));
System.out.println(Math.min(23.12,23.0));
}
}
```

This produces the following result:

```
12.123
23.0
```

max()

Description:

The method gives the maximum of the two arguments. The argument can be int, float, long, double.

Syntax:

This method has following variants:

```
double max(double arg1,double arg2)
float max(float arg1,float arg2)
int max(int arg1,int arg2)
long max(long arg1,long arg2)
```

Parameters:

Here is the detail of parameters:

- A primitive data types

Return Value:

- This method returns the maximum of the two arguments.

Example:

```
public class Test{  
  
    public static void main(String args[]){  
        System.out.println(Math.max(12.123,12.456));  
        System.out.println(Math.max(23.12,23.0));  
    }  
}
```

This produces the following result:

```
12.456  
23.12
```

exp()

Description:

The method returns the base of the natural logarithms, e, to the power of the argument.

Syntax:

```
double exp(double d)
```

Parameters:

Here is the detail of parameters:

- **d** -- A primitive data types

Return Value:

- This method Returns the base of the natural logarithms, e, to the power of the argument.

Example:

```
public class Test{  
  
    public static void main(String args[]){  
        double x =11.635;  
        double y =2.76;  
  
        System.out.printf("The value of e is %.4f%n",Math.E);  
    }  
}
```

TUTORIALS POINT

Simply Easy Learning

```
System.out.printf("exp(%.3f) is %.3f%n", x, Math.exp(x));
}
}
```

This produces the following result:

```
The value of e is 2.7183
exp(11.635) is 112983.831
```

log()

Description:

The method returns the natural logarithm of the argument.

Syntax:

```
double log(double d)
```

Parameters:

Here is the detail of parameters:

- **d** -- A primitive data types

Return Value:

- This method Returns the natural logarithm of the argument.

Example:

```
public class Test{
    public static void main(String args[]){
        double x =11.635;
        double y =2.76;

        System.out.printf("The value of e is %.4f%n",Math.E);
        System.out.printf("log(%.3f) is %.3f%n", x,Math.log(x));
    }
}
```

This produces the following result:

```
The value of e is 2.7183
log(11.635) is 2.454
```

pow()

Description:

The method returns the value of the first argument raised to the power of the second argument.

Syntax:

```
double pow(double base, double exponent)
```

Parameters:

Here is the detail of parameters:

- **base** -- A primitive data type
- **exponent** -- A primitive data type

Return Value:

- This method Returns the value of the first argument raised to the power of the second argument.

Example:

```
public class Test{  
  
    public static void main(String args[]){  
        double x =11.635;  
        double y =2.76;  
  
        System.out.printf("The value of e is %.4f\n",Math.E);  
        System.out.printf("pow(%.3f, %.3f) is %.3f\n",x, y,Math.pow(x, y));  
  
    }  
}
```

This produces the following result:

```
The value of e is 2.7183  
pow(11.635, 2.760) is 874.008
```

sqrt()

Description:

The method returns the square root of the argument.

Syntax:

```
double sqrt(double d)
```

Parameters:

Here is the detail of parameters:

- **d** -- A primitive data type

Return Value:

- This method Returns the square root of the argument.

Example:

```
public class Test{  
  
    public static void main(String args[]){  
        double x =11.635;  
        double y =2.76;  
  
        System.out.printf("The value of e is %.4f%n",Math.E);  
        System.out.printf("sqrt(%.3f) is %.3f%n", x,Math.sqrt(x));  
    }  
}
```

This produces the following result:

```
The value of e is 2.7183  
sqrt(11.635) is 3.411
```

sin()

Description:

The method returns the sine of the specified double value.

Syntax:

```
double sin(double d)
```

Parameters:

Here is the detail of parameters:

- **d** -- A double data types

Return Value:

- This method Returns the sine of the specified double value.

Example:

```
public class Test{  
  
    public static void main(String args[]){  
        double degrees =45.0;
```

```
double radians =Math.toRadians(degrees);

System.out.format("The value of pi is %.4f%n",Math.PI);
System.out.format("The sine of %.1f degrees is
%.4f%n",degrees,Math.sin(radians));

}
}
```

This produces the following result:

```
The value of pi is 3.1416
The sine of 45.0 degrees is 0.7071
```

cos()

Description:

The method returns the cosine of the specified double value.

Syntax:

```
double cos(double d)
```

Parameters:

Here is the detail of parameters:

- **d** -- A double data types

Return Value:

- This method Returns the cosine of the specified double value.

Example:

```
public class Test{

public static void main(String args[]){
double degrees =45.0;
double radians =Math.toRadians(degrees);

System.out.format("The value of pi is %.4f%n",Math.PI);
System.out.format("The cosine of %.1f degrees is %.4f%n",
degrees,Math.cos(radians));

}
}
```

This produces the following result:

```
The value of pi is 3.1416
The cosine of 45.0 degrees is 0.7071
```

tan()

Description:

The method returns the tangent of the specified double value.

Syntax:

```
double tan(double d)
```

Parameters:

Here is the detail of parameters:

- **d** -- A double data type

Return Value:

- This method returns the tangent of the specified double value.

Example:

```
public class Test{

public static void main(String args[]){
double degrees =45.0;
double radians =Math.toRadians(degrees);

System.out.format("The value of pi is %.4f%n",Math.PI);
System.out.format("The tangent of %.1f degrees is %.4f%n",
degrees,Math.tan(radians));

}
}
```

This produces the following result:

```
The value of pi is 3.1416
The tangent of 45.0 degrees is 1.0000
```

asin()

Description:

The method returns the arcsine of the specified double value.

Syntax:

```
double asin(double d)
```

Parameters:

Here is the detail of parameters:

- **d** -- A double data types

Return Value:

- This method Returns the arcsine of the specified double value.

Example:

```
public class Test{  
  
    public static void main(String args[]){  
        double degrees =45.0;  
        double radians =Math.toRadians(degrees);  
  
        System.out.format("The value of pi is %.4f\n",Math.PI);  
        System.out.format("The arcsine of %.4f is %.4f degrees \n",  
            Math.sin(radians),  
            Math.toDegrees(Math.asin(Math.sin(radians))));  
  
    }  
}
```

This produces the following result:

```
The value of pi is 3.1416  
The arcsine of 0.7071 is 45.0000 degrees
```

acos()

Description:

The method returns the arccosine of the specified double value.

Syntax:

```
double acos(double d)
```

Parameters:

Here is the detail of parameters:

- **d** -- A double data types

Return Value:

- This method Returns the arccosine of the specified double value.

Example:

```
public class Test{  
  
    public static void main(String args[]){  
        double degrees =45.0;  
        double radians =Math.toRadians(degrees);  
  
        System.out.format("The value of pi is %.4f%n",Math.PI);  
        System.out.format("The arccosine of %.4f is %.4f degrees %n",  
            Math.cos(radians),  
            Math.toDegrees(Math.acos(Math.sin(radians))));  
  
    }  
}
```

This produces the following result:

```
The value of pi is 3.1416  
The arccosine of 0.7071 is 45.0000 degrees
```

atan()

Description:

The method returns the arctangent of the specified double value.

Syntax:

```
double atan(double d)
```

Parameters:

Here is the detail of parameters:

- **d** -- A double data types

Return Value :

- This method Returns the arctangent of the specified double value.

Example:

```
public class Test{

public static void main(String args[]){
double degrees =45.0;
double radians =Math.toRadians(degrees);

System.out.format("The value of pi is %.4f%n",Math.PI);
System.out.format("The arctangent of %.4f is %.4f degrees %n",
Math.cos(radians),
Math.toDegrees(Math.atan(Math.sin(radians))));

}
}
```

This produces the following result:

```
The value of pi is 3.1416
The arctangent of 1.0000 is 45.0000 degrees
```

atan2()

Description:

The method Converts rectangular coordinates (x, y) to polar coordinate (r, theta) and returns theta.

Syntax:

```
double atan2(double y, double x)
```

Parameters:

Here is the detail of parameters:

- **X** -- X co-ordinate in double data type
- **Y** -- Y co-ordinate in double data type

Return Value:

- This method Returns theta from polar coordinate (r, theta)

Example:

```
public class Test{

public static void main(String args[]){
double x =45.0;
double y =30.0;
```

```
System.out.println(Math.atan2(x, y));  
}  
}
```

This produces the following result:

```
0.982793723247329
```

toDegrees()

Description:

The method converts the argument value to degrees.

Syntax:

```
double toDegrees(double d)
```

Parameters:

Here is the detail of parameters:

- **d** -- A double data type.

Return Value:

- This method returns a double value.

Example:

```
public class Test{  
  
    public static void main(String args[]){  
        double x =45.0;  
        double y =30.0;  
  
        System.out.println(Math.toDegrees(x));  
        System.out.println(Math.toDegrees(y));  
    }  
}
```

This produces the following result:

```
2578.3100780887044  
1718.8733853924698
```

toRadians()

Description:

The method converts the argument value to radians.

Syntax:

```
double toRadians(double d)
```

Parameters:

Here is the detail of parameters:

- **d** -- A double data type.

Return Value:

- This method returns a double value.

Example:

```
public class Test{  
  
    public static void main(String args[]){  
        double x =45.0;  
        double y =30.0;  
  
        System.out.println(Math.toRadians(x));  
        System.out.println(Math.toRadians(y));  
    }  
}
```

This produces the following result:

```
0.7853981633974483  
0.5235987755982988
```

random()

Description:

The method is used to generate a random number between 0.0 and 1.0. The range is: $0.0 \leq \text{Math.random} < 1.0$. Different ranges can be achieved by using arithmetic.

Syntax:

```
static double random()
```

Parameters:

Here is the detail of parameters:

- NA

Return Value:

- This method returns a double

Example:

```
public class Test{  
  
    public static void main(String args[]){  
        System.out.println(Math.random());  
        System.out.println(Math.random());  
    }  
}
```

This produces the following result:

```
0.16763945061451657  
0.400551253762343
```

Note: Above result would vary every time you would call random() method.

What is Next?

In the next section, we will be going through the Character class in Java. You will be learning how to use object Characters and primitive data type char in Java.

Java Characters

Normally, when we work with characters, we use primitive data types `char`.

Example:

```
char ch = 'a';

// Unicode for uppercase Greek omega character
char uniChar = '\u0391';

// an array of chars
char[] charArray = {'a', 'b', 'c', 'd', 'e'};
```

However in development, we come across situations where we need to use objects instead of primitive data types. In order to achieve this, Java provides wrapper class **Character** for primitive data type `char`.

The `Character` class offers a number of useful class (i.e., static) methods for manipulating characters. You can create a `Character` object with the `Character` constructor:

```
Character ch = new Character('a');
```

The Java compiler will also create a `Character` object for you under some circumstances. For example, if you pass a primitive `char` into a method that expects an object, the compiler automatically converts the `char` to a `Character` for you. This feature is called autoboxing or unboxing, if the conversion goes the other way.

Example:

```
// Here following primitive char 'a'
// is boxed into the Character object ch
Character ch = 'a';

// Here primitive 'x' is boxed for method test,
// return is unboxed to char 'c'
char c = test('x');
```

Escape Sequences:

A character preceded by a backslash (`\`) is an escape sequence and has special meaning to the compiler.

The newline character (\n) has been used frequently in this tutorial in System.out.println() statements to advance to the next line after the string is printed.

Following table shows the Java escape sequences:

Escape Sequence	Description
\t	Inserts a tab in the text at this point.
\b	Inserts a backspace in the text at this point.
\n	Inserts a newline in the text at this point.
\r	Inserts a carriage return in the text at this point.
\f	Inserts a form feed in the text at this point.
\'	Inserts a single quote character in the text at this point.
\"	Inserts a double quote character in the text at this point.
\\	Inserts a backslash character in the text at this point.

When an escape sequence is encountered in a print statement, the compiler interprets it accordingly.

Example:

If you want to put quotes within quotes you must use the escape sequence, \", on the interior quotes:

```
public class Test{  
  
    public static void main(String args[]){  
        System.out.println("She said \"Hello!\" to me.");  
    }  
}
```

This would produce the following result:

```
She said "Hello!" to me.
```

Character Methods:

Here is the list of the important instance methods that all the subclasses of the Character class implement:

SN	Methods with Description
1	isLetter() Determines whether the specified char value is a letter.
2	isDigit() Determines whether the specified char value is a digit.
3	isWhitespace() Determines whether the specified char value is white space.
4	isUpperCase() Determines whether the specified char value is uppercase.

5	isLowerCase() Determines whether the specified char value is lowercase.
6	toUpperCase() Returns the uppercase form of the specified char value.
7	toLowerCase() Returns the lowercase form of the specified char value.
8	toString() Returns a String object representing the specified character value that is, a one-character string.

For a complete list of methods, please refer to the [java.lang.Character API specification](#).

isLetter()

Description:

The method determines whether the specified char value is a letter.

Syntax:

```
boolean isLetter(char ch)
```

Parameters:

Here is the detail of parameters:

- **ch** -- Primitive character type

Return Value:

- This method Returns true if passed character is really a character.

Example:

```
public class Test{  
  
    public static void main(String args[]){  
        System.out.println(Character.isLetter('c'));  
        System.out.println(Character.isLetter('5'));  
    }  
}
```

This produces the following result:

```
true  
false
```

isDigit()

Description:

The method determines whether the specified char value is a digit.

Syntax:

```
boolean isDigit(char ch)
```

Parameters:

Here is the detail of parameters:

- **ch** -- Primitive character type

Return Value:

- This method Returns true if passed character is really a digit.

Example:

```
public class Test{  
  
    public static void main(String args[]){  
        System.out.println(Character.isDigit('c'));  
        System.out.println(Character.isDigit('5'));  
    }  
}
```

This produces the following result:

```
false  
true
```

isWhitespace()

Description:

The method determines whether the specified char value is a white space, which includes space, tab or new line.

Syntax:

```
boolean isWhitespace(char ch)
```

Parameters:

Here is the detail of parameters:

- **ch** -- Primitive character type

Return Value:

- This method Returns true if passed character is really a white space.

Example:

```
public class Test{  
  
    public static void main(String args[]){  
        System.out.println(Character.isWhitespace('c'));  
        System.out.println(Character.isWhitespace(' '));  
        System.out.println(Character.isWhitespace('\n'));  
        System.out.println(Character.isWhitespace('\t'));  
    }  
}
```

This produces the following result:

```
false  
true  
true  
true
```

isUpperCase()

Description:

The method determines whether the specified char value is uppercase.

Syntax:

```
boolean isUpperCase(char ch)
```

Parameters:

Here is the detail of parameters:

- **ch** -- Primitive character type

Return Value:

- This method Returns true if passed character is really an uppercase.

Example:

```
public class Test{  
  
    public static void main(String args[]){  
        System.out.println(Character.isUpperCase('c'));  
        System.out.println(Character.isUpperCase('C'));  
        System.out.println(Character.isUpperCase('\n'));  
        System.out.println(Character.isUpperCase('\t'));  
    }  
}
```

This produces the following result:

```
false  
true  
false  
false
```

isLowerCase()

Description:

The method determines whether the specified char value is lowercase.

Syntax:

```
boolean isLowerCase(char ch)
```

Parameters:

Here is the detail of parameters:

- **ch** -- Primitive character type

Return Value:

- This method Returns true if passed character is really an lowercase.

Example:

```
public class Test{  
  
    public static void main(String args[]){  
        System.out.println(Character.isLowerCase('c'));  
        System.out.println(Character.isLowerCase('C'));  
        System.out.println(Character.isLowerCase('\n'));  
        System.out.println(Character.isLowerCase('\t'));  
    }  
}
```

This produces the following result:

```
true  
false  
false  
false
```

toUpperCase()

Description:

The method returns the uppercase form of the specified char value.

Syntax:

```
char toUpperCase(char ch)
```

Parameters:

Here is the detail of parameters:

- **ch** -- Primitive character type

Return Value :

- This method Returns the uppercase form of the specified char value.

Example:

```
public class Test{  
  
    public static void main(String args[]){  
        System.out.println(Character.toUpperCase('c'));  
        System.out.println(Character.toUpperCase('C'));  
    }  
}
```

This produces the following result:

```
C  
C
```

toLowerCase()

Description:

The method returns the lowercase form of the specified char value.

Syntax:

```
char toLowerCase(char ch)
```

Parameters:

Here is the detail of parameters:

- **ch** -- Primitive character type

Return Value:

- This method Returns the lowercase form of the specified char value.

Example:

```
public class Test{  
  
    public static void main(String args[]){  
        System.out.println(Character.toLowerCase('c'));  
        System.out.println(Character.toLowerCase('C'));  
    }  
}
```

This produces the following result:

```
c  
c
```

toString()

Description:

The method returns a String object representing the specified character value, that is, a one-character string.

Syntax:

```
String toString(char ch)
```

Parameters:

Here is the detail of parameters:

- **ch** -- Primitive character type

Return Value:

- This method Returns String object

Example:

```
public class Test{  
  
    public static void main(String args[]){  
        System.out.println(Character.toString('c'));  
        System.out.println(Character.toString('C'));  
    }  
}
```

This produces the following result:

```
c  
C
```

What is Next?

In the next section, we will be going through the String class in Java. You will be learning how to declare and use Strings efficiently as well as some of the important methods in the String class.

Java Strings

Strings which are widely used in Java programming are a sequence of characters. In the Java programming language, strings are objects.

The Java platform provides the String class to create and manipulate strings.

Creating Strings:

The most direct way to create a string is to write:

```
String greeting ="Hello world!";
```

Whenever it encounters a string literal in your code, the compiler creates a String object with its value, in this case, "Hello world!".

As with any other object, you can create String objects by using the new keyword and a constructor. The String class has eleven constructors that allow you to provide the initial value of the string using different sources, such as an array of characters:

```
public class StringDemo{  
  
    public static void main(String args[]){  
        char[] helloArray ={'h','e','l','l','o','.'};  
        String helloString =new String(helloArray);  
        System.out.println(helloString);  
    }  
}
```

This would produce the following result:

```
hello.
```

Note: The String class is immutable, so that once it is created a String object cannot be changed. If there is a necessity to make a lot of modifications to Strings of characters, then you should use [String Buffer & String Builder](#) Classes.

String Length:

Methods used to obtain information about an object are known as accessor methods. One accessor method that you can use with strings is the length() method, which returns the number of characters contained in the string object.

TUTORIALS POINT

Simply Easy Learning

After the following two lines of code have been executed, len equals 17:

```
public class StringDemo{  
  
    public static void main(String args[]){  
        String palindrome ="Dot saw I was Tod";  
        int len = palindrome.length();  
        System.out.println("String Length is : "+ len );  
    }  
}
```

This would produce the following result:

```
StringLengthis:17
```

Concatenating Strings:

The String class includes a method for concatenating two strings:

```
string1.concat(string2);
```

This returns a new string that is string1 with string2 added to it at the end. You can also use the concat() method with string literals, as in:

```
"My name is ".concat("Zara");
```

Strings are more commonly concatenated with the + operator, as in:

```
"Hello, "+" world"+"!"
```

which results in:

```
"Hello, world!"
```

Let us look at the following example:

```
public class StringDemo{  
  
    public static void main(String args[]){  
        String string1 ="saw I was ";  
        System.out.println("Dot "+ string1 +"Tod");  
    }  
}
```

This would produce the following result:

```
Dot saw I was Tod
```

Creating Format Strings:

You have printf() and format() methods to print output with formatted numbers. The String class has an equivalent class method, format(), that returns a String object rather than a PrintStream object.

Using String's static format() method allows you to create a formatted string that you can reuse, as opposed to a one-time print statement. For example, instead of:

```
System.out.printf("The value of the float variable is "+
```



```
"%f, while the value of the integer "+  
"variable is %d, and the string "+  
"is %s", floatVar, intVar, stringVar);
```

you can write:

```
String fs;  
fs =String.format("The value of the float variable is "+  
"%f, while the value of the integer "+  
"variable is %d, and the string "+  
"is %s", floatVar, intVar, stringVar);  
System.out.println(fs);
```

String Methods:

Here is the list of methods supported by String class:

SN	Methods with Description
1	<u>char charAt(int index)</u> Returns the character at the specified index.
2	<u>int compareTo(Object o)</u> Compares this String to another Object.
3	<u>int compareTo(String anotherString)</u> Compares two strings lexicographically.
4	<u>int compareToIgnoreCase(String str)</u> Compares two strings lexicographically, ignoring case differences.
5	<u>String concat(String str)</u> Concatenates the specified string to the end of this string.
6	<u>boolean contentEquals(StringBuffer sb)</u> Returns true if and only if this String represents the same sequence of characters as the specified StringBuffer.
7	<u>static String copyValueOf(char[] data)</u> Returns a String that represents the character sequence in the array specified.
8	<u>static String copyValueOf(char[] data, int offset, int count)</u> Returns a String that represents the character sequence in the array specified.
9	<u>boolean endsWith(String suffix)</u> Tests if this string ends with the specified suffix.
10	<u>boolean equals(Object anObject)</u> Compares this string to the specified object.
11	<u>boolean equalsIgnoreCase(String anotherString)</u> Compares this String to another String, ignoring case considerations.
12	<u>byte getBytes()</u> Encodes this String into a sequence of bytes using the platform's default charset, storing the result into a new byte array.
13	<u>byte[] getBytes(String charsetName)</u> Encodes this String into a sequence of bytes using the named charset, storing the result into a new byte array.

14	<u>void getChars(int srcBegin, int srcEnd, char[] dst, int dstBegin)</u> Copies characters from this string into the destination character array.
15	<u>int hashCode()</u> Returns a hash code for this string.
16	<u>int indexOf(int ch)</u> Returns the index within this string of the first occurrence of the specified character.
17	<u>int indexOf(int ch, int fromIndex)</u> Returns the index within this string of the first occurrence of the specified character, starting the search at the specified index.
18	<u>int indexOf(String str)</u> Returns the index within this string of the first occurrence of the specified substring.
19	<u>int indexOf(String str, int fromIndex)</u> Returns the index within this string of the first occurrence of the specified substring, starting at the specified index.
20	<u>String intern()</u> Returns a canonical representation for the string object.
21	<u>int lastIndexOf(int ch)</u> Returns the index within this string of the last occurrence of the specified character.
22	<u>int lastIndexOf(int ch, int fromIndex)</u> Returns the index within this string of the last occurrence of the specified character, searching backward starting at the specified index.
23	<u>int lastIndexOf(String str)</u> Returns the index within this string of the rightmost occurrence of the specified substring.
24	<u>int lastIndexOf(String str, int fromIndex)</u> Returns the index within this string of the last occurrence of the specified substring, searching backward starting at the specified index.
25	<u>int length()</u> Returns the length of this string.
26	<u>boolean matches(String regex)</u> Tells whether or not this string matches the given regular expression.
27	<u>boolean regionMatches(boolean ignoreCase, int toffset, String other, int ooffset, int len)</u> Tests if two string regions are equal.
28	<u>boolean regionMatches(int toffset, String other, int ooffset, int len)</u> Tests if two string regions are equal.
29	<u>String replace(char oldChar, char newChar)</u> Returns a new string resulting from replacing all occurrences of oldChar in this string with newChar.
30	<u>String replaceAll(String regex, String replacement)</u> Replaces each substring of this string that matches the given regular expression with the given replacement.
31	<u>String replaceFirst(String regex, String replacement)</u> Replaces the first substring of this string that matches the given regular expression with the given replacement.

32	<u>String[] split(String regex)</u> Splits this string around matches of the given regular expression.
33	<u>String[] split(String regex, int limit)</u> Splits this string around matches of the given regular expression.
34	<u>boolean startsWith(String prefix)</u> Tests if this string starts with the specified prefix.
35	<u>boolean startsWith(String prefix, int toffset)</u> Tests if this string starts with the specified prefix beginning a specified index.
36	<u>CharSequence subSequence(int beginIndex, int endIndex)</u> Returns a new character sequence that is a subsequence of this sequence.
37	<u>String substring(int beginIndex)</u> Returns a new string that is a substring of this string.
38	<u>String substring(int beginIndex, int endIndex)</u> Returns a new string that is a substring of this string.
39	<u>char[] toCharArray()</u> Converts this string to a new character array.
40	<u>String toLowerCase()</u> Converts all of the characters in this String to lower case using the rules of the default locale.
41	<u>String toLowerCase(Locale locale)</u> Converts all of the characters in this String to lower case using the rules of the given Locale.
42	<u>String toString()</u> This object (which is already a string!) is itself returned.
43	<u>String toUpperCase()</u> Converts all of the characters in this String to upper case using the rules of the default locale.
44	<u>String toUpperCase(Locale locale)</u> Converts all of the characters in this String to upper case using the rules of the given Locale.
45	<u>String trim()</u> Returns a copy of the string, with leading and trailing whitespace omitted.
46	<u>static String valueOf(primitive data type x)</u> Returns the string representation of the passed data type argument.

The above mentioned methods are explained here:

char charAt(int index)

Description:

This method returns the character located at the String's specified index. The string indexes start from zero.

Syntax:

Here is the syntax of this method:

```
public char charAt(int index)
```

Parameters:

Here is the detail of parameters:

- **index** -- Index of the character to be returned.

Return Value:

- This method Returns a char at the specified index.

Example:

```
public class Test{  
  
    public static void main(String args[]){  
        String s ="Strings are immutable";  
        char result = s.charAt(8);  
        System.out.println(result);  
    }  
}
```

This produces the following result:

```
a
```

int compareTo(Object o)

Description:

There are two variants of this method. First method compares this String to another Object and second method compares two strings lexicographically.

Syntax:

Here is the syntax of this method:

```
int compareTo(Object o)  
  
or  
  
int compareTo(String anotherString)
```

Parameters:

Here is the detail of parameters:

- **o** -- the Object to be compared.
- **anotherString** -- the String to be compared.

Return Value :

- The value 0 if the argument is a string lexicographically equal to this string; a value less than 0 if the argument is a string lexicographically greater than this string; and a value greater than 0 if the argument is a string lexicographically less than this string.

Example:

```
public class Test{  
  
    public static void main(String args[]){  
        String str1 ="Strings are immutable";  
        String str2 ="Strings are immutable";  
        String str3 ="Integers are not immutable";  
  
        int result = str1.compareTo( str2 );  
        System.out.println(result);  
  
        result = str2.compareTo( str3 );  
        System.out.println(result);  
  
        result = str3.compareTo( str1 );  
        System.out.println(result);  
    }  
}
```

This produces the following result:

```
0  
10  
-10
```

int compareTo(String anotherString)

Description:

There are two variants of this method. First method compares this String to another Object and second method compares two strings lexicographically.

Syntax:

Here is the syntax of this method:

```
int compareTo(Object o)  
  
or  
  
int compareTo(String anotherString)
```

Parameters:

Here is the detail of parameters:

- **o** -- the Object to be compared.
- **anotherString** -- the String to be compared.

TUTORIALS POINT

Simply Easy Learning

Return Value :

- The value 0 if the argument is a string lexicographically equal to this string; a value less than 0 if the argument is a string lexicographically greater than this string; and a value greater than 0 if the argument is a string lexicographically less than this string.

Example:

```
public class Test{

public static void main(String args[]){
String str1 ="Strings are immutable";
String str2 ="Strings are immutable";
String str3 ="Integers are not immutable";

int result = str1.compareTo( str2 );
System.out.println(result);

    result = str2.compareTo( str3 );
System.out.println(result);

    result = str3.compareTo( str1 );
System.out.println(result);
}
}
```

This produces the following result:

```
0
10
-10
```

int compareToIgnoreCase(String str)

Description:

This method compares two strings lexicographically, ignoring case differences.

Syntax:

Here is the syntax of this method:

```
int compareToIgnoreCase( String str)
```

Parameters:

Here is the detail of parameters:

- **str** -- the String to be compared.

Return Value:

- This method returns a negative integer, zero, or a positive integer as the specified String is greater than, equal to, or less than this String, ignoring case considerations.

Example:

```
public class Test{

public static void main(String args[]){
String str1 ="Strings are immutable";
String str2 ="Strings are immutable";
String str3 ="Integers are not immutable";

int result = str1.compareToIgnoreCase( str2 );
System.out.println(result);

    result = str2.compareToIgnoreCase( str3 );
System.out.println(result);

    result = str3.compareToIgnoreCase( str1 );
System.out.println(result);
}
}
```

This produces the following result:

```
0
10
-10
```

String concat(String str)

Description:

This method appends one String to the end of another. The method returns a String with the value of the String passed in to the method appended to the end of the String used to invoke this method.

Syntax:

Here is the syntax of this method:

```
public String concat (String s)
```

Parameters:

Here is the detail of parameters:

- **s** -- the String that is concatenated to the end of this String.

Return Value :

- This methods returns a string that represents the concatenation of this object's characters followed by the string argument's characters.

Example:

```
public class Test{  
  
    public static void main(String args[]){  
        String s ="Strings are immutable";  
        s = s.concat(" all the time");  
        System.out.println(s);  
    }  
}
```

This produces the following result:

```
Strings are immutable all the time
```

boolean contentEquals(StringBuffer sb)

Description:

This method returns true if and only if this String represents the same sequence of characters as the specified in StringBuffer.

Syntax:

Here is the syntax of this method:

```
public boolean contentEquals (StringBuffer sb)
```

Parameters:

Here is the detail of parameters:

- **sb** -- the StringBuffer to compare.

Return Value:

- This method returns true if and only if this String represents the same sequence of characters as the specified in StringBuffer, otherwise false.

Example:

```
public class Test{  
  
    public static void main(String args[]){  
        String str1 ="Not immutable";  
        String str2 ="Strings are immutable";  
        StringBuffer str3 =new StringBuffer("Not immutable");  
    }  
}
```

TUTORIALS POINT

Simply Easy Learning

```

boolean result = str1.contentEquals( str3 );
System.out.println(result);

    result = str2.contentEquals( str3 );
System.out.println(result);
}
}

```

This produces the following result:

```

true
false

```

static String copyValueOf(char[] data)

Description:

This method has two different forms:

- **public static String copyValueOf(char[] data):** Returns a String that represents the character sequence in the array specified.
- **public static String copyValueOf(char[] data, int offset, int count):** Returns a String that represents the character sequence in the array specified.

Syntax:

Here is the syntax of this method:

```

public staticString copyValueOf(char[] data)
or
public staticString copyValueOf(char[] data,int offset,int count)

```

Parameters:

Here is the detail of parameters:

- **data** -- the character array.
- **offset** -- initial offset of the subarray.
- **count** -- length of the subarray.

Return Value :

- This method returns a String that contains the characters of the character array.

Example:

```

public class Test{
public static void main(String args[]){
char[]Str1={'h','e','l','l','o',' ',' ','w','o','r','l','d'};

```

TUTORIALS POINT

Simply Easy Learning

```
String Str2="";

Str2=Str2.copyValueOf(Str1);
System.out.println("Returned String: "+Str2);

Str2=Str2.copyValueOf(Str1,2,6);
System.out.println("Returned String: "+Str2);
}
}
```

This produces the following result:

```
Returned String: hello world
Returned String: llo wo
```

boolean endsWith(String suffix)

Description:

This method tests if this string ends with the specified suffix.

Syntax:

Here is the syntax of this method:

```
public boolean endsWith(String suffix)
```

Parameters:

Here is the detail of parameters:

- **suffix** -- the suffix.

Return Value:

- This method returns true if the character sequence represented by the argument is a suffix of the character sequence represented by this object; false otherwise. Note that the result will be true if the argument is the empty string or is equal to this String object as determined by the equals(Object) method.

Example:

```
public class Test{

public static void main(String args[]){
String Str=new String("This is really not immutable!!");
boolean retVal;

    retVal =Str.endsWith("immutable!!");
System.out.println("Returned Value = "+ retVal );

    retVal =Str.endsWith("immu");
}
```

TUTORIALS POINT

Simply Easy Learning

```
System.out.println("Returned Value = "+ retVal );
}
}
```

This produces the following result:

```
Returned Value = true
Returned Value = false
```

boolean equals(Object anObject)

Description:

This method compares this string to the specified object. The result is true if and only if the argument is not null and is a String object that represents the same sequence of characters as this object.

Syntax:

Here is the syntax of this method:

```
public boolean equals(Object anObject)
```

Parameters:

Here is the detail of parameters:

- **anObject** -- the object to compare this String against.

Return Value :

- This method returns true if the String are equal; false otherwise.

Example:

```
public class Test{

public static void main(String args[]){
String Str1=new String("This is really not immutable!!");
String Str2=Str1;
String Str3=new String("This is really not immutable!!");
boolean retVal;

    retVal =Str1.equals(Str2);
System.out.println("Returned Value = "+ retVal );

    retVal =Str1.equals(Str3);
System.out.println("Returned Value = "+ retVal );
}
}
```

This produces the following result:

```
Returned Value = true
Returned Value = true
```

boolean equalsIgnoreCase(String anotherString)

Description:

This method compares this String to another String, ignoring case considerations. Two strings are considered equal ignoring case if they are of the same length, and corresponding characters in the two strings are equal ignoring case.

Syntax:

Here is the syntax of this method:

```
public boolean equalsIgnoreCase(String anotherString)
```

Parameters:

Here is the detail of parameters:

- **anotherString** -- the String to compare this String against

Return Value:

- This method returns true if the argument is not null and the Strings are equal, ignoring case; false otherwise.

Example:

```
public class Test{

    public static void main(String args[]){
        String Str1=new String("This is really not immutable!!");
        String Str2=Str1;
        String Str3=new String("This is really not immutable!!");
        String Str4=new String("This IS REALLY NOT IMMUTABLE!!");
        boolean retVal;

        retVal =Str1.equals(Str2);
        System.out.println("Returned Value = "+ retVal );

        retVal =Str1.equals(Str3);
        System.out.println("Returned Value = "+ retVal );

        retVal =Str1.equalsIgnoreCase(Str4);
        System.out.println("Returned Value = "+ retVal );
    }
}
```

This produces the following result:

```
Returned Value = true
Returned Value = true
Returned Value = true
```

byte getBytes()

Description:

This method has following two forms:

- **getBytes(String charsetName):** Encodes this String into a sequence of bytes using the named charset, storing the result into a new byte array.
- **getBytes():** Encodes this String into a sequence of bytes using the platform's default charset, storing the result into a new byte array.

Syntax:

Here is the syntax of this method:

```
public byte[] getBytes(String charsetName)
throwsUnsupportedEncodingException

or

public byte[] getBytes()
```

Parameters:

Here is the detail of parameters:

- **charsetName** -- the name of a supported charset.

Return Value:

- This method returns the resultant byte array

Example:

```
import java.io.*;

public class Test{

public static void main(String args[]){
String Str1=new String("Welcome to Tutorialspoint.com");

try{
byte[]Str2=Str1.getBytes();
System.out.println("Returned Value "+Str2);

Str2=Str1.getBytes("UTF-8");
System.out.println("Returned Value "+Str2);
```

```
Str2=Str1.getBytes("ISO-8859-1");
System.out.println("Returned Value "+Str2);
}catch(UnsupportedEncodingException e){
System.out.println("Unsupported character set");
}
}
}
```

This produces the following result:

```
Returned Value [B@192d342
Returned Value [B@15ff48b
Returned Value [B@1b90b39
```

byte[] getBytes(String charsetName)

Description:

This method has following two forms:

- **getBytes(String charsetName):** Encodes this String into a sequence of bytes using the named charset, storing the result into a new byte array.
- **getBytes():** Encodes this String into a sequence of bytes using the platform's default charset, storing the result into a new byte array.

Syntax:

Here is the syntax of this method:

```
public byte[] getBytes(String charsetName)
throws UnsupportedOperationException

or

public byte[] getBytes()
```

Parameters:

Here is the detail of parameters:

- **charsetName** -- the name of a supported charset.

Return Value:

- This method returns the resultant byte array

Example:

```
import java.io.*;

public class Test{
```

```

public static void main(String args[]){
String Str1=new String("Welcome to Tutorialspoint.com");

try{
byte[]Str2=Str1.getBytes();
System.out.println("Returned Value "+Str2);

Str2=Str1.getBytes("UTF-8");
System.out.println("Returned Value "+Str2);

Str2=Str1.getBytes("ISO-8859-1");
System.out.println("Returned Value "+Str2);
}catch(UnsupportedEncodingException e){
System.out.println("Unsupported character set");
}
}
}

```

This produces the following result:

```

Returned Value [B@192d342
Returned Value [B@15ff48b
Returned Value [B@1b90b39

```

void getChars(int srcBegin, int srcEnd, char[] dst, int dstBegin)

Description:

This method copies characters from this string into the destination character array.

Syntax:

Here is the syntax of this method:

```

public void getChars(int srcBegin,
int srcEnd,
char[] dst,
int dstBegin)

```

Parameters:

Here is the detail of parameters:

- **srcBegin** -- index of the first character in the string to copy.
- **srcEnd** -- index after the last character in the string to copy.
- **dst** -- the destination array.
- **dstBegin** -- the start offset in the destination array.

Return Value:

- It does not return any value but throws `IndexOutOfBoundsException`.

Example:

```
import java.io.*;

public class Test{
    public static void main(String args[]){
        String Str1=new String("Welcome to Tutorialspoint.com");
        char []Str2=newchar[7];

        try{
            Str1.getChars(2,9,Str2,0);
            System.out.print("Copied Value = ");
            System.out.println(Str2);

        }catch(Exception ex){
            System.out.println("Raised exception...");
        }
    }
}
```

This produces the following result:

```
Copied Value = lcome t
```

int hashCode()

Description:

This method returns a hash code for this string. The hash code for a `String` object is computed as:

$$s[0]*31^{(n-1)} + s[1]*31^{(n-2)} + \dots + s[n-1]$$

Using int arithmetic, where $s[i]$ is the i th character of the string, n is the length of the string, and $^$ indicates exponentiation. (The hash value of the empty string is zero.)

Syntax:

Here is the syntax of this method:

```
public int hashCode()
```

Parameters:

Here is the detail of parameters:

- **NA**

Return Value:

- This method returns a hash code value for this object.

Example:

```
import java.io.*;

public class Test{
public static void main(String args[]){
String Str=new String("Welcome to Tutorialspoint.com");
System.out.println("Hashcode for Str :"+Str.hashCode());
}
}
```

This produces the following result:

```
Hashcode for Str :1186874997
```

int indexOf(int ch)

Description:

This method has following different variants:

- **public int indexOf(int ch):** Returns the index within this string of the first occurrence of the specified character or -1 if the character does not occur.
- **public int indexOf(int ch, int fromIndex):** Returns the index within this string of the first occurrence of the specified character, starting the search at the specified index or -1 if the character does not occur.
- **int indexOf(String str):** Returns the index within this string of the first occurrence of the specified substring. If it does not occur as a substring, -1 is returned.
- **int indexOf(String str, int fromIndex):** Returns the index within this string of the first occurrence of the specified substring, starting at the specified index. If it does not occur, -1 is returned.

Syntax:

Here is the syntax of this method:

```
public int indexOf(int ch )

or

public int indexOf(int ch,int fromIndex)

or

int indexOf(String str)

or

int indexOf(String str,int fromIndex)
```

Parameters:

Here is the detail of parameters:

- **ch** -- a character.
- **fromIndex** -- the index to start the search from.
- **str** -- a string.

Return Value:

- See the description.

Example:

```
import java.io.*;

public class Test{

public static void main(String args[]){
String Str=new String("Welcome to Tutorialspoint.com");
StringSubStr1=new String("Tutorials");
StringSubStr2=new String("Sutorials");

System.out.print("Found Index :");
System.out.println(Str.indexOf('o'));
System.out.print("Found Index :");
System.out.println(Str.indexOf('o',5));
System.out.print("Found Index :");
System.out.println(Str.indexOf(SubStr1));
System.out.print("Found Index :");
System.out.println(Str.indexOf(SubStr1,15));
System.out.print("Found Index :");
System.out.println(Str.indexOf(SubStr2));
}
}
```

This produces the following result:

```
Found Index :4
Found Index :9
Found Index :11
Found Index :-1
Found Index :-1
```

int indexOf(int ch, int fromIndex)

Description:

This method has following different variants:

- **public int indexOf(int ch):** Returns the index within this string of the first occurrence of the specified character or -1 if the character does not occur.
- **public int indexOf(int ch, int fromIndex):** Returns the index within this string of the first occurrence of the specified character, starting the search at the specified index or -1 if the character does not occur.
- **int indexOf(String str):** Returns the index within this string of the first occurrence of the specified substring. If it does not occur as a substring, -1 is returned.

- **int indexOf(String str, int fromIndex):** Returns the index within this string of the first occurrence of the specified substring, starting at the specified index. If it does not occur, -1 is returned.

Syntax:

Here is the syntax of this method:

```
public int indexOf(int ch )  
  
or  
  
public int indexOf(int ch,int fromIndex)  
  
or  
  
int indexOf(String str)  
  
or  
  
int indexOf(String str,int fromIndex)
```

Parameters:

Here is the detail of parameters:

- **ch** -- a character.
- **fromIndex** -- the index to start the search from.
- **str** -- a string.

Return Value:

- See the description.

Example:

```
import java.io.*;  
  
public class Test{  
  
    public static void main(String args[]){  
        String Str=new String("Welcome to Tutorialspoint.com");  
        String SubStr1=new String("Tutorials");  
        String SubStr2=new String("Sutorials");  
  
        System.out.print("Found Index :");  
        System.out.println(Str.indexOf('o'));  
        System.out.print("Found Index :");  
        System.out.println(Str.indexOf('o',5));  
        System.out.print("Found Index :");  
        System.out.println(Str.indexOf(SubStr1));  
        System.out.print("Found Index :");  
        System.out.println(Str.indexOf(SubStr1,15));  
        System.out.print("Found Index :");  
        System.out.println(Str.indexOf(SubStr2));  
    }  
}
```

```
}  
}
```

This produces the following result:

```
Found Index :4  
Found Index :9  
Found Index :11  
Found Index :-1  
Found Index :-1
```

int indexOf(String str)

Description:

This method has following different variants:

- **public int indexOf(int ch):** Returns the index within this string of the first occurrence of the specified character or -1 if the character does not occur.
- **public int indexOf(int ch, int fromIndex):** Returns the index within this string of the first occurrence of the specified character, starting the search at the specified index or -1 if the character does not occur.
- **int indexOf(String str):** Returns the index within this string of the first occurrence of the specified substring. If it does not occur as a substring, -1 is returned.
- **int indexOf(String str, int fromIndex):** Returns the index within this string of the first occurrence of the specified substring, starting at the specified index. If it does not occur, -1 is returned.

Syntax:

Here is the syntax of this method:

```
public int indexOf(int ch )  
  
or  
  
public int indexOf(int ch,int fromIndex)  
  
or  
  
int indexOf(String str)  
  
or  
  
int indexOf(String str,int fromIndex)
```

Parameters:

Here is the detail of parameters:

- **ch** -- a character.
- **fromIndex** -- the index to start the search from.
- **str** -- a string.

Return Value:

- See the description.

Example:

```
import java.io.*;

public class Test{

public static void main(String args[]){
String Str=new String("Welcome to Tutorialspoint.com");
StringSubStr1=new String("Tutorials");
StringSubStr2=new String("Sutorials");

System.out.print("Found Index :");
System.out.println(Str.indexOf('o'));
System.out.print("Found Index :");
System.out.println(Str.indexOf('o',5));
System.out.print("Found Index :");
System.out.println(Str.indexOf(SubStr1));
System.out.print("Found Index :");
System.out.println(Str.indexOf(SubStr1,15));
System.out.print("Found Index :");
System.out.println(Str.indexOf(SubStr2));
}
}
```

This produces the following result:

```
Found Index :4
Found Index :9
Found Index :11
Found Index :-1
Found Index :-1
```

int indexOf(String str, int fromIndex)

Description:

This method has following different variants:

- **public int indexOf(int ch):** Returns the index within this string of the first occurrence of the specified character or -1 if the character does not occur.
- **public int indexOf(int ch, int fromIndex):** Returns the index within this string of the first occurrence of the specified character, starting the search at the specified index or -1 if the character does not occur.
- **int indexOf(String str):** Returns the index within this string of the first occurrence of the specified substring. If it does not occur as a substring, -1 is returned.
- **int indexOf(String str, int fromIndex):** Returns the index within this string of the first occurrence of the specified substring, starting at the specified index. If it does not occur, -1 is returned.

Syntax:

Here is the syntax of this method:

```
public int indexOf(int ch )  
  
or  
  
public int indexOf(int ch,int fromIndex)  
  
or  
  
int indexOf(String str)  
  
or  
  
int indexOf(String str,int fromIndex)
```

Parameters:

Here is the detail of parameters:

- **ch** -- a character.
- **fromIndex** -- the index to start the search from.
- **str** -- a string.

Return Value:

- See the description.

Example:

```
import java.io.*;  
  
public class Test{  
  
    public static void main(String args[]){  
        String Str=new String("Welcome to Tutorialspoint.com");  
        String SubStr1=new String("Tutorials");  
        String SubStr2=new String("Sutorials");  
  
        System.out.print("Found Index :");  
        System.out.println(Str.indexOf('o'));  
        System.out.print("Found Index :");  
        System.out.println(Str.indexOf('o',5));  
        System.out.print("Found Index :");  
        System.out.println(Str.indexOf(SubStr1));  
        System.out.print("Found Index :");  
        System.out.println(Str.indexOf(SubStr1,15));  
        System.out.print("Found Index :");  
        System.out.println(Str.indexOf(SubStr2));  
    }  
}
```

This produces the following result:

```
Found Index :4
```

```
Found Index :9
Found Index :11
Found Index :-1
Found Index :-1
```

String intern()

Description:

This method returns a canonical representation for the string object. It follows that for any two strings s and t, s.intern() == t.intern() is true if and only if s.equals(t) is true.

Syntax:

Here is the syntax of this method:

```
public String intern()
```

Parameters:

Here is the detail of parameters:

- **NA**

Return Value:

- This method returns a canonical representation for the string object.

Example:

```
import java.io.*;

public class Test{
public static void main(String args[]){
String Str1=new String("Welcome to Tutorialspoint.com");
String Str2=new String("WELCOME TO SUTORIALSPOINT.COM");

System.out.print("Canonical representation:");
System.out.println(Str1.intern());

System.out.print("Canonical representation:");
System.out.println(Str2.intern());
}
}
```

This produces the following result:

```
Canonical representation: Welcome to Tutorialspoint.com
Canonical representation: WELCOME TO SUTORIALSPOINT.COM
```

int lastIndexOf(int ch)

Description:

This method has the following variants:

- **int lastIndexOf(int ch):** Returns the index within this string of the last occurrence of the specified character or -1 if the character does not occur.
- **public int lastIndexOf(int ch, int fromIndex):** Returns the index of the last occurrence of the character in the character sequence represented by this object that is less than or equal to fromIndex, or -1 if the character does not occur before that point.
- **public int lastIndexOf(String str):** If the string argument occurs one or more times as a substring within this object, then it returns the index of the first character of the last such substring is returned. If it does not occur as a substring, -1 is returned.
- **public int lastIndexOf(String str, int fromIndex):** Returns the index within this string of the last occurrence of the specified substring, searching backward starting at the specified index.

Syntax:

Here is the syntax of this method:

```
int lastIndexOf(int ch)
or
public int lastIndexOf(int ch,int fromIndex)
or
public int lastIndexOf(String str)
or
public int lastIndexOf(String str,int fromIndex)
```

Parameters:

Here is the detail of parameters:

- **ch** -- a character.
- **fromIndex** -- the index to start the search from.
- **str** -- A string.

Return Value:

- This method returns the index.

Example:

```
import java.io.*;
public class Test{
```



```

public static void main(String args[]){
String Str=new String("Welcome to Tutorialspoint.com");
String SubStr1=new String("Tutorials");
String SubStr2=new String("Sutorials");

System.out.print("Found Last Index :");
System.out.println(Str.lastIndexOf('o'));
System.out.print("Found Last Index :");
System.out.println(Str.lastIndexOf('o',5));
System.out.print("Found Last Index :");
System.out.println(Str.lastIndexOf(SubStr1));
System.out.print("Found Last Index :");
System.out.println(Str.lastIndexOf(SubStr1,15));
System.out.print("Found Last Index :");
System.out.println(Str.lastIndexOf(SubStr2));
}
}

```

This produces the following result:

```

Found Last Index :27
Found Last Index :4
Found Last Index :11
Found Last Index :11
Found Last Index :-1

```

int lastIndexOf(int ch, int fromIndex)

Description:

This method has the following variants:

- **int lastIndexOf(int ch):** Returns the index within this string of the last occurrence of the specified character or -1 if the character does not occur.
- **public int lastIndexOf(int ch, int fromIndex):** Returns the index of the last occurrence of the character in the character sequence represented by this object that is less than or equal to fromIndex, or -1 if the character does not occur before that point.
- **public int lastIndexOf(String str):** If the string argument occurs one or more times as a substring within this object, then it returns the index of the first character of the last such substring is returned. If it does not occur as a substring, -1 is returned.
- **public int lastIndexOf(String str, int fromIndex):** Returns the index within this string of the last occurrence of the specified substring, searching backward starting at the specified index.

Syntax:

Here is the syntax of this method:

```

int lastIndexOf(int ch)

or

public int lastIndexOf(int ch,int fromIndex)

```

```
or

public int lastIndexOf(String str)

or

public int lastIndexOf(String str,int fromIndex)
```

Parameters:

Here is the detail of parameters:

- **ch** -- a character.
- **fromIndex** -- the index to start the search from.
- **str** -- A string.

Return Value:

- This method returns the index.

Example:

```
import java.io.*;

public class Test{

public static void main(String args[]){
String Str=new String("Welcome to Tutorialspoint.com");
String SubStr1=new String("Tutorials");
String SubStr2=new String("Sutorials");

System.out.print("Found Last Index :");
System.out.println(Str.lastIndexOf('o'));
System.out.print("Found Last Index :");
System.out.println(Str.lastIndexOf('o',5));
System.out.print("Found Last Index :");
System.out.println(Str.lastIndexOf(SubStr1));
System.out.print("Found Last Index :");
System.out.println(Str.lastIndexOf(SubStr1,15));
System.out.print("Found Last Index :");
System.out.println(Str.lastIndexOf(SubStr2));
}
}
```

This produces the following result:

```
Found Last Index :27
Found Last Index :4
Found Last Index :11
Found Last Index :11
Found Last Index :-1
```

int lastIndexOf(String str)

Description:

This method has the following variants:

- **int lastIndexOf(int ch):** Returns the index within this string of the last occurrence of the specified character or -1 if the character does not occur.
- **public int lastIndexOf(int ch, int fromIndex):** Returns the index of the last occurrence of the character in the character sequence represented by this object that is less than or equal to fromIndex, or -1 if the character does not occur before that point.
- **public int lastIndexOf(String str):** If the string argument occurs one or more times as a substring within this object, then it returns the index of the first character of the last such substring is returned. If it does not occur as a substring, -1 is returned.
- **public int lastIndexOf(String str, int fromIndex):** Returns the index within this string of the last occurrence of the specified substring, searching backward starting at the specified index.

Syntax:

Here is the syntax of this method:

```
int lastIndexOf(int ch)
or
public int lastIndexOf(int ch,int fromIndex)
or
public int lastIndexOf(String str)
or
public int lastIndexOf(String str,int fromIndex)
```

Parameters:

Here is the detail of parameters:

- **ch** -- a character.
- **fromIndex** -- the index to start the search from.
- **str** -- A string.

Return Value:

- This method returns the index.

Example:

```
import java.io.*;
public class Test{
```

```

public static void main(String args[]){
String Str=new String("Welcome to Tutorialspoint.com");
String SubStr1=new String("Tutorials");
String SubStr2=new String("Sutorials");

System.out.print("Found Last Index :");
System.out.println(Str.lastIndexOf('o'));
System.out.print("Found Last Index :");
System.out.println(Str.lastIndexOf('o',5));
System.out.print("Found Last Index :");
System.out.println(Str.lastIndexOf(SubStr1));
System.out.print("Found Last Index :");
System.out.println(Str.lastIndexOf(SubStr1,15));
System.out.print("Found Last Index :");
System.out.println(Str.lastIndexOf(SubStr2));
}
}

```

This produces the following result:

```

Found Last Index :27
Found Last Index :4
Found Last Index :11
Found Last Index :11
Found Last Index :-1

```

int lastIndexOf(String str, int fromIndex)

Description:

This method has the following variants:

- **int lastIndexOf(int ch):** Returns the index within this string of the last occurrence of the specified character or -1 if the character does not occur.
- **public int lastIndexOf(int ch, int fromIndex):** Returns the index of the last occurrence of the character in the character sequence represented by this object that is less than or equal to fromIndex, or -1 if the character does not occur before that point.
- **public int lastIndexOf(String str):** If the string argument occurs one or more times as a substring within this object, then it returns the index of the first character of the last such substring is returned. If it does not occur as a substring, -1 is returned.
- **public int lastIndexOf(String str, int fromIndex):** Returns the index within this string of the last occurrence of the specified substring, searching backward starting at the specified index.

Syntax:

Here is the syntax of this method:

```

int lastIndexOf(int ch)

or

public int lastIndexOf(int ch,int fromIndex)

```

```
or

public int lastIndexOf(String str)

or

public int lastIndexOf(String str,int fromIndex)
```

Parameters:

Here is the detail of parameters:

- **ch** -- a character.
- **fromIndex** -- the index to start the search from.
- **str** -- A string.

Return Value:

- This method returns the index.

Example:

```
import java.io.*;

public class Test{

public static void main(String args[]){
String Str=new String("Welcome to Tutorialspoint.com");
String SubStr1=new String("Tutorials");
String SubStr2=new String("Sutorials");

System.out.print("Found Last Index :");
System.out.println(Str.lastIndexOf('o'));
System.out.print("Found Last Index :");
System.out.println(Str.lastIndexOf('o',5));
System.out.print("Found Last Index :");
System.out.println(Str.lastIndexOf(SubStr1));
System.out.print("Found Last Index :");
System.out.println(Str.lastIndexOf(SubStr1,15));
System.out.print("Found Last Index :");
System.out.println(Str.lastIndexOf(SubStr2));
}
}
```

This produces the following result:

```
Found Last Index :27
Found Last Index :4
Found Last Index :11
Found Last Index :11
Found Last Index :-1
```

int length()

Description:

This method returns the length of this string. The length is equal to the number of 16-bit Unicode characters in the string.

Syntax:

Here is the syntax of this method:

```
public int length()
```

Parameters:

Here is the detail of parameters:

- NA

Return Value:

- This method returns the the length of the sequence of characters represented by this object.

Example:

```
import java.io.*;

public class Test{
public static void main(String args[]){
String Str1=new String("Welcome to Tutorialspoint.com");
String Str2=new String("Tutorials");

System.out.print("String Length :");
System.out.println(Str1.length());

System.out.print("String Length :");
System.out.println(Str2.length());
}
}
```

This produces the following result:

```
String Length :29
String Length :9
```

boolean matches(String regex)

Description:

This method tells whether or not this string matches the given regular expression. An invocation of this method of the form `str.matches(regex)` yields exactly the same result as the expression `Pattern.matches(regex, str)`.

Syntax:

Here is the syntax of this method:

```
public boolean matches(String regex)
```

Parameters:

Here is the detail of parameters:

- **regex** -- the regular expression to which this string is to be matched.

Return Value:

- This method returns true if, and only if, this string matches the given regular expression.

Example:

```
import java.io.*;

public class Test{
public static void main(String args[]){
String Str=new String("Welcome to Tutorialspoint.com");

System.out.print("Return Value :");
System.out.println(Str.matches("(.*?)Tutorials(.*?)"));

System.out.print("Return Value :");
System.out.println(Str.matches("Tutorials"));

System.out.print("Return Value :");
System.out.println(Str.matches("Welcome(.*?)"));
}
}
```

This produces the following result:

```
Return Value :true
Return Value :false
Return Value :true
```

boolean regionMatches(boolean ignoreCase, int toffset, String other, int ooffset, int len)

Description:

This method has two variants which can be used to test if two string regions are equal.

Syntax:

Here is the syntax of this method:

```
public boolean regionMatches(int toffset,
String other,
int ooffset,
int len)

or

public boolean regionMatches(boolean ignoreCase,
int toffset,
String other,
int ooffset,
int len)
```

Parameters:

Here is the detail of parameters:

- **toffset** -- the starting offset of the subregion in this string.
- **other** -- the string argument.
- **ooffset** -- the starting offset of the subregion in the string argument.
- **len** -- the number of characters to compare.
- **ignoreCase** -- if true, ignore case when comparing characters.

Return Value:

- It returns true if the specified subregion of this string matches the specified subregion of the string argument; false otherwise. Whether the matching is exact or case insensitive depends on the ignoreCase argument.

Example:

```
import java.io.*;

public class Test{
public static void main(String args[]){
String Str1=new String("Welcome to Tutorialspoint.com");
String Str2=new String("Tutorials");
String Str3=new String("TUTORIALS");

System.out.print("Return Value :");
System.out.println(Str1.regionMatches(11,Str2,0,9));

System.out.print("Return Value :");
System.out.println(Str1.regionMatches(11,Str3,0,9));

System.out.print("Return Value :");
System.out.println(Str1.regionMatches(true,11,Str3,0,9));
}
```



```
}
```

This produces the following result:

```
Return Value :true  
Return Value :false  
Return Value :true
```

boolean regionMatches(int toffset, String other, int ooffset, int len)

Description:

This method has two variants which can be used to test if two string regions are equal.

Syntax:

Here is the syntax of this method:

```
public boolean regionMatches(int toffset,  
String other,  
int ooffset,  
int len)  
  
or  
  
public boolean regionMatches(boolean ignoreCase,  
int toffset,  
String other,  
int ooffset,  
int len)
```

Parameters:

Here is the detail of parameters:

- **toffset** -- the starting offset of the subregion in this string.
- **other** -- the string argument.
- **ooffset** -- the starting offset of the subregion in the string argument.
- **len** -- the number of characters to compare.
- **ignoreCase** -- if true, ignore case when comparing characters.

Return Value:

- It returns true if the specified subregion of this string matches the specified subregion of the string argument; false otherwise. Whether the matching is exact or case insensitive depends on the ignoreCase argument.

Example:

```

import java.io.*;

public class Test{
public static void main(String args[]){
String Str1=new String("Welcome to Tutorialspoint.com");
String Str2=new String("Tutorials");
String Str3=new String("TUTORIALS");

System.out.print("Return Value :");
System.out.println(Str1.regionMatches(11,Str2,0,9));

System.out.print("Return Value :");
System.out.println(Str1.regionMatches(11,Str3,0,9));

System.out.print("Return Value :");
System.out.println(Str1.regionMatches(true,11,Str3,0,9));
}
}

```

This produces the following result:

```

Return Value :true
Return Value :false
Return Value :true

```

String replace(char oldChar, char newChar)

Description:

This method returns a new string resulting from replacing all occurrences of oldChar in this string with newChar.

Syntax:

Here is the syntax of this method:

```

public String replace(char oldChar, char newChar)

```

Parameters:

Here is the detail of parameters:

- **oldChar** -- the old character.
- **newChar** -- the new character.

Return Value:

- It returns a string derived from this string by replacing every occurrence of oldChar with newChar.

Example:

```

import java.io.*;

```

TUTORIALS POINT
Simply Easy Learning

```

public class Test{
public static void main(String args[]){
String Str=new String("Welcome to Tutorialspoint.com");

System.out.print("Return Value :");
System.out.println(Str.replace('o','T'));

System.out.print("Return Value :");
System.out.println(Str.replace('l','D'));
}
}

```

This produces the following result:

```

Return Value :WelcTme tT TutTrialspTint.cTm
Return Value :WeDcome to TutoriaDspoint.com

```

String replaceAll(String regex, String replacement)

Description:

This method replaces each substring of this string that matches the given regular expression with the given replacement.

Syntax:

Here is the syntax of this method:

```

public String replaceAll(String regex,String replacement)

```

Parameters:

Here is the detail of parameters:

- **regex** -- the regular expression to which this string is to be matched.
- **replacement** -- the string which would replace found expression.

Return Value:

- This method returns the resulting String.

Example:

```

import java.io.*;

public class Test{
public static void main(String args[]){
String Str=new String("Welcome to Tutorialspoint.com");

System.out.print("Return Value :");

```

```
System.out.println(Str.replaceAll("(.*)Tutorials(.*)",
"AMROOD"));
}
}
```

This produces the following result:

```
Return Value :AMROOD
```

String replaceFirst(String regex, String replacement)

Description:

This method replaces the first substring of this string that matches the given regular expression with the given replacement.

Syntax:

Here is the syntax of this method:

```
public String replaceFirst(String regex, String replacement)
```

Parameters:

Here is the detail of parameters:

- **regex** -- the regular expression to which this string is to be matched.
- **replacement** -- the string which would replace found expression.

Return Value :

- This method returns a resulting String.

Example:

```
import java.io.*;

public class Test{
public static void main(String args[]){
String Str=new String("Welcome to Tutorialspoint.com");

System.out.print("Return Value :");
System.out.println(Str.replaceFirst("(.*)Tutorials(.*)",
"AMROOD"));

System.out.print("Return Value :");
System.out.println(Str.replaceFirst("Tutorials","AMROOD"));
}
}
```

This produces the following result:

```
Return Value :AMROOD  
Return Value :Welcome to AMROODpoint.com
```

String[] split(String regex)

Description:

This method has two variants and splits this string around matches of the given regular expression.

Syntax:

Here is the syntax of this method:

```
public String[] split(String regex,int limit)  
  
or  
  
public String[] split(String regex)
```

Parameters:

Here is the detail of parameters:

- **regex** -- the delimiting regular expression.
- **limit** -- the result threshold which means how many strings to be returned.

Return Value:

- It returns the array of strings computed by splitting this string around matches of the given regular expression.

Example:

```
import java.io.*;  
  
public class Test{  
public static void main(String args[]){  
String Str=new String("Welcome-to-Tutorialspoint.com");  
  
System.out.println("Return Value :");  
for(String retval:Str.split("-",2)){  
System.out.println(retval);  
}  
System.out.println("");  
System.out.println("Return Value :");  
for(String retval:Str.split("-",3)){  
System.out.println(retval);  
}  
System.out.println("");  
System.out.println("Return Value :");  
for(String retval:Str.split("-",0)){  
System.out.println(retval);  
}}
```

```
}  
System.out.println("");  
System.out.println("Return Value :");  
for(String retval:Str.split("-")){  
System.out.println(retval);  
}  
}  
}
```

This produces the following result:

```
Return Value :  
Welcome  
to-Tutorialspoint.com  
  
Return Value :  
Welcome  
to  
Tutorialspoint.com  
  
Return Value:  
Welcome  
to  
Tutorialspoint.com  
  
Return Value :  
Welcome  
to  
Tutorialspoint.com
```

String[] split(String regex, int limit)

Description:

This method has two variants and splits this string around matches of the given regular expression.

Syntax:

Here is the syntax of this method:

```
public String[] split(String regex,int limit)  
  
or  
  
public String[] split(String regex)
```

Parameters:

Here is the detail of parameters:

- **regex** -- the delimiting regular expression.
- **limit** -- the result threshold which means how many strings to be returned.

Return Value:

- It returns the array of strings computed by splitting this string around matches of the given regular expression.

Example:

```
import java.io.*;

public class Test{
public static void main(String args[]){
String Str=new String("Welcome-to-Tutorialspoint.com");

System.out.println("Return Value :");
for(String retval:Str.split("-",2)){
System.out.println(retval);
}
System.out.println("");
System.out.println("Return Value :");
for(String retval:Str.split("-",3)){
System.out.println(retval);
}
System.out.println("");
System.out.println("Return Value :");
for(String retval:Str.split("-",0)){
System.out.println(retval);
}
System.out.println("");
System.out.println("Return Value :");
for(String retval:Str.split("-")){
System.out.println(retval);
}
}
}
```

This produces the following result:

```
Return Value :
Welcome
to-Tutorialspoint.com

Return Value :
Welcome
to
Tutorialspoint.com

Return Value:
Welcome
to
Tutorialspoint.com

Return Value :
Welcome
to
Tutorialspoint.com
```

boolean startsWith(String prefix)

Description:

This method has two variants and tests if a string starts with the specified prefix beginning a specified index or by default at the beginning.

Syntax:

Here is the syntax of this method:

```
public boolean startsWith(String prefix,int toffset)

or

public boolean startsWith(String prefix)
```

Parameters:

Here is the detail of parameters:

- **prefix** -- the prefix to be matched.
- **toffset** -- where to begin looking in the string.

Return Value:

- It returns true if the character sequence represented by the argument is a prefix of the character sequence represented by this string; false otherwise.

Example:

```
import java.io.*;

public class Test{
public static void main(String args[]){
String Str=new String("Welcome to Tutorialspoint.com");

System.out.print("Return Value :");
System.out.println(Str.startsWith("Welcome"));

System.out.print("Return Value :");
System.out.println(Str.startsWith("Tutorials"));

System.out.print("Return Value :");
System.out.println(Str.startsWith("Tutorials",11));
}
}
```

This produces the following result:

```
Return Value :true
Return Value :false
```



```
Return Value :true
```

boolean startsWith(String prefix, int toffset)

Description:

This method has two variants and tests if a string starts with the specified prefix beginning a specified index or by default at the beginning.

Syntax:

Here is the syntax of this method:

```
public boolean startsWith(String prefix,int toffset)
or
public boolean startsWith(String prefix)
```

Parameters:

Here is the detail of parameters:

- **prefix** -- the prefix to be matched.
- **toffset** -- where to begin looking in the string.

Return Value:

- It returns true if the character sequence represented by the argument is a prefix of the character sequence represented by this string; false otherwise.

Example:

```
import java.io.*;

public class Test{
public static void main(String args[]){
String Str=new String("Welcome to Tutorialspoint.com");

System.out.print("Return Value :");
System.out.println(Str.startsWith("Welcome"));

System.out.print("Return Value :");
System.out.println(Str.startsWith("Tutorials"));

System.out.print("Return Value :");
System.out.println(Str.startsWith("Tutorials",11));
}
}
```

This produces the following result:

```
Return Value :true  
Return Value :false  
Return Value :true
```

CharSequence subSequence(int beginIndex, int endIndex)

Description:

This method returns a new character sequence that is a subsequence of this sequence.

Syntax:

Here is the syntax of this method:

```
public CharSequence subSequence(int beginIndex, int endIndex)
```

Parameters:

Here is the detail of parameters:

- **beginIndex** -- the begin index, inclusive.
- **endIndex** -- the end index, exclusive.

Return Value:

- This method returns the specified subsequence.

Example:

```
import java.io.*;  
  
public class Test{  
public static void main(String args[]){  
String Str=new String("Welcome to Tutorialspoint.com");  
  
System.out.print("Return Value :");  
System.out.println(Str.subSequence(0,10));  
  
System.out.print("Return Value :");  
System.out.println(Str.subSequence(10,15));  
}  
}
```

This produces the following result:

```
Return Value :Welcome to  
Return Value : Tuto
```

String substring(int beginIndex)

Description:

This method has two variants and returns a new string that is a substring of this string. The substring begins with the character at the specified index and extends to the end of this string or up to endIndex - 1 if second argument is given.

Syntax:

Here is the syntax of this method:

```
public String substring(int beginIndex)
or
public String substring(int beginIndex,int endIndex)
```

Parameters:

Here is the detail of parameters:

- **beginIndex** -- the begin index, inclusive.
- **endIndex** -- the end index, exclusive.

Return Value:

- The specified substring.

Example:

```
import java.io.*;

public class Test{
public static void main(String args[]){
String Str=new String("Welcome to Tutorialspoint.com");

System.out.print("Return Value :");
System.out.println(Str.substring(10));

System.out.print("Return Value :");
System.out.println(Str.substring(10,15));
}
}
```

This produces the following result:

```
Return Value : Tutorialspoint.com
Return Value : Tuto
```

String substring(int beginIndex, int endIndex)

Description:

This method has two variants and returns a new string that is a substring of this string. The substring begins with the character at the specified index and extends to the end of this string or up to `endIndex - 1` if second argument is given.

Syntax:

Here is the syntax of this method:

```
public String substring(int beginIndex)

or

public String substring(int beginIndex, int endIndex)
```

Parameters:

Here is the detail of parameters:

- **beginIndex** -- the begin index, inclusive.
- **endIndex** -- the end index, exclusive.

Return Value:

- The specified substring.

Example:

```
import java.io.*;

public class Test{
public static void main(String args[]){
String Str=new String("Welcome to Tutorialspoint.com");

System.out.print("Return Value :");
System.out.println(Str.substring(10));

System.out.print("Return Value :");
System.out.println(Str.substring(10,15));
}
}
```

This produces the following result:

```
Return Value : Tutorialspoint.com
Return Value : Tuto
```

char[] toCharArray()

Description:

This method converts this string to a new character array.

Syntax:

Here is the syntax of this method:

```
public char[] toCharArray()
```

Parameters:

Here is the detail of parameters:

- **NA**

Return Value:

- It returns a newly allocated character array, whose length is the length of this string and whose contents are initialized to contain the character sequence represented by this string.

Example:

```
import java.io.*;

public class Test{
public static void main(String args[]){
String Str=new String("Welcome to Tutorialspoint.com");

System.out.print("Return Value :");
System.out.println(Str.toCharArray());
}
}
```

This produces the following result:

```
Return Value :Welcome to Tutorialspoint.com
```

String toLowerCase()

Description:

This method has two variants. First variant converts all of the characters in this String to lower case using the rules of the given Locale. This is equivalent to calling toLowerCase(Locale.getDefault()).

Second variant takes locale as an argument to be used while converting into lower case.

Syntax:

Here is the syntax of this method:

```
public String toLowerCase()  
  
or  
  
public String toLowerCase(Locale locale)
```

Parameters:

Here is the detail of parameters:

- NA

Return Value:

- It returns the String, converted to lowercase.

Example:

```
import java.io.*;  
  
public class Test{  
    public static void main(String args[]){  
        String Str=new String("Welcome to Tutorialspoint.com");  
  
        System.out.print("Return Value :");  
        System.out.println(Str.toLowerCase());  
    }  
}
```

This produces the following result:

```
Return Value :welcome to tutorialspoint.com
```

String toLowerCase(Locale locale)

Description:

This method has two variants. First variant converts all of the characters in this String to lower case using the rules of the given Locale. This is equivalent to calling toLowerCase(Locale.getDefault()).

Second variant takes locale as an argument to be used while converting into lower case.

Syntax:

Here is the syntax of this method:

```
public String toLowerCase()
```

or

```
public String toLowerCase(Locale locale)
```

Parameters:

Here is the detail of parameters:

- NA

Return Value:

- It returns the String, converted to lowercase.

Example:

```
import java.io.*;

public class Test{
public static void main(String args[]){
String Str=new String("Welcome to Tutorialspoint.com");

System.out.print("Return Value :");
System.out.println(Str.toLowerCase());
}
}
```

This produces the following result:

```
Return Value :welcome to tutorialspoint.com
```

String toString()

Description:

This method returns itself a string

Syntax:

Here is the syntax of this method:

```
public String toString()
```

Parameters:

Here is the detail of parameters:

- NA

Return Value:

- This method returns the string itself.

Example:

```
import java.io.*;

public class Test{
public static void main(String args[]){
String Str=new String("Welcome to Tutorialspoint.com");

System.out.print("Return Value :");
System.out.println(Str.toString());
}
}
```

This produces the following result:

```
Return Value :Welcome to Tutorialspoint.com
```

String toUpperCase()

Description:

This method has two variants. First variant converts all of the characters in this String to upper case using the rules of the given Locale. This is equivalent to calling toUpperCase(Locale.getDefault()).

Second variant takes locale as an argument to be used while converting into upper case.

Syntax:

Here is the syntax of this method:

```
public String toUpperCase()

or

public String toUpperCase(Locale locale)
```

Parameters:

Here is the detail of parameters:

- **NA**

Return Value:

- It returns the String, converted to uppercase.

Example:

```
import java.io.*;

public class Test{
public static void main(String args[]){
String Str=new String("Welcome to Tutorialspoint.com");

System.out.print("Return Value :");
System.out.println(Str.toUpperCase());
}
}
```

This produces the following result:

```
Return Value :WELCOME TO TUTORIALSPOINT.COM
```

String toUpperCase(Locale locale)

Description:

This method has two variants. First variant converts all of the characters in this String to upper case using the rules of the given Locale. This is equivalent to calling toUpperCase(Locale.getDefault()).

Second variant takes locale as an argument to be used while converting into upper case.

Syntax:

Here is the syntax of this method:

```
public String toUpperCase()

or

public String toUpperCase(Locale locale)
```

Parameters:

Here is the detail of parameters:

- NA

Return Value:

- It returns the String, converted to uppercase.

Example:

```
import java.io.*;

public class Test{
```

```
public static void main(String args[]){
String Str=new String("Welcome to Tutorialspoint.com");

System.out.print("Return Value :");
System.out.println(Str.toUpperCase());
}
}
```

This produces the following result:

```
Return Value :WELCOME TO TUTORIALSPOINT.COM
```

String trim()

Description:

This method returns a copy of the string, with leading and trailing whitespace omitted.

Syntax:

Here is the syntax of this method:

```
publicString trim()
```

Parameters:

Here is the detail of parameters:

- **NA**

Return Value:

- It returns a copy of this string with leading and trailing white space removed, or this string if it has no leading or trailing white space.

Example:

```
import java.io.*;

public class Test{
public static void main(String args[]){
String Str=new String("  Welcome to Tutorialspoint.com  ");

System.out.print("Return Value :");
System.out.println(Str.trim());
}
}
```

This produces the following result:

```
Return Value :Welcome to Tutorialspoint.com
```

static String valueOf(primitive data type x)

Description:

This method has followings variants, which depend on the passed parameters. This method returns the string representation of the passed argument.

- **valueOf(boolean b):** Returns the string representation of the boolean argument.
- **valueOf(char c):** Returns the string representation of the char argument.
- **valueOf(char[] data):** Returns the string representation of the char array argument.
- **valueOf(char[] data, int offset, int count):** Returns the string representation of a specific subarray of the char array argument.
- **valueOf(double d):** Returns the string representation of the double argument.
- **valueOf(float f):** Returns the string representation of the float argument.
- **valueOf(int i):** Returns the string representation of the int argument.
- **valueOf(long l):** Returns the string representation of the long argument.
- **valueOf(Object obj):** Returns the string representation of the Object argument.

Syntax:

Here is the syntax of this method:

```
static String valueOf(boolean b)
or
static String valueOf(char c)
or
static String valueOf(char[] data)
or
static String valueOf(char[] data,int offset,int count)
or
static String valueOf(double d)
or
static String valueOf(float f)
or
static String valueOf(int i)
or
static String valueOf(long l)
or
```

```
static String valueOf(Object obj)
```

Parameters:

Here is the detail of parameters:

- **See the description.**

Return Value :

- This method returns the string representation.

Example:

```
import java.io.*;

public class Test{
public static void main(String args[]){
double d =102939939.939;
boolean b =true;
long l =1232874;
char[] arr ={'a','b','c','d','e','f','g'};

System.out.println("Return Value : "+String.valueOf(d));
System.out.println("Return Value : "+String.valueOf(b));
System.out.println("Return Value : "+String.valueOf(l));
System.out.println("Return Value : "+String.valueOf(arr));
}
}
```

This produces the following result:

```
Return Value : 1.02939939939E8
Return Value : true
Return Value : 1232874
Return Value : abcdefg
```

Java Arrays

Java provides a data structure, the **array**, which stores a fixed-size sequential collection of elements of the same type. An array is used to store a collection of data, but it is often more useful to think of an array as a collection of variables of the same type.

Instead of declaring individual variables, such as `number0`, `number1`, ..., and `number99`, you declare one array variable such as `numbers` and use `numbers[0]`, `numbers[1]`, and ..., `numbers[99]` to represent individual variables.

This tutorial introduces how to declare array variables, create arrays, and process arrays using indexed variables.

Declaring Array Variables:

To use an array in a program, you must declare a variable to reference the array, and you must specify the type of array the variable can reference. Here is the syntax for declaring an array variable:

```
dataType[] arrayRefVar; // preferred way.  
  
or  
  
dataType arrayRefVar[]; // works but not preferred way.
```

Note: The style `dataType[] arrayRefVar` is preferred. The style `dataType arrayRefVar[]` comes from the C/C++ language and was adopted in Java to accommodate C/C++ programmers.

Example:

The following code snippets are examples of this syntax:

```
double[] myList; // preferred way.  
  
or  
  
double myList[]; // works but not preferred way.
```

Creating Arrays:

You can create an array by using the `new` operator with the following syntax:

```
arrayRefVar = new dataType[arraySize];
```

The above statement does two things:

- It creates an array using `new dataType[arraySize]`;
- It assigns the reference of the newly created array to the variable `arrayRefVar`.

Declaring an array variable, creating an array, and assigning the reference of the array to the variable can be combined in one statement, as shown below:

```
dataType[] arrayRefVar =new dataType[arraySize];
```

Alternatively you can create arrays as follows:

```
dataType[] arrayRefVar ={value0, value1,..., valuek};
```

The array elements are accessed through the **index**. Array indices are 0-based; that is, they start from 0 to **arrayRefVar.length-1**.

Example:

Following statement declares an array variable, `myList`, creates an array of 10 elements of double type and assigns its reference to `myList`:

```
double[] myList =new double[10];
```

Following picture represents array `myList`. Here, `myList` holds ten double values and the indices are from 0 to 9.

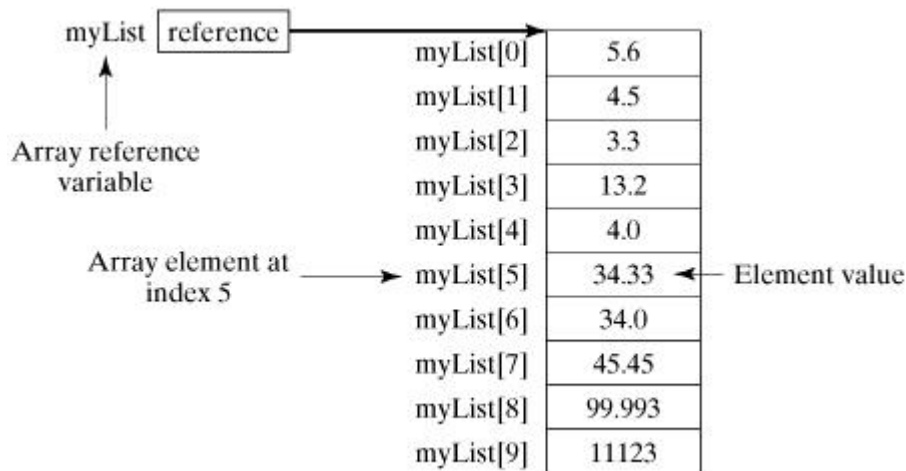

Processing Arrays:

When processing array elements, we often use either for loop or foreach loop because all of the elements in an array are of the same type and the size of the array is known.

Example:

Here is a complete example of showing how to create, initialize and process arrays:

```
public class TestArray{
    public static void main(String[] args){
        double[] myList ={1.9,2.9,3.4,3.5};
        // Print all the array elements
        for(int i =0; i < myList.length; i++){
```

```

System.out.println(myList[i]+" ");
}
// Summing all elements
double total =0;
for(int i =0; i < myList.length; i++){
total += myList[i];
}
System.out.println("Total is "+ total);
// Finding the largest element
double max = myList[0];
for(int i =1; i < myList.length; i++){
if(myList[i]> max) max = myList[i];
}
System.out.println("Max is "+ max);
}
}

```

This would produce the following result:

```

1.9
2.9
3.4
3.5
Totalis11.7
Maxis3.5

```

The foreach Loops:

JDK 1.5 introduced a new for loop known as foreach loop or enhanced for loop, which enables you to traverse the complete array sequentially without using an index variable.

Example:

The following code displays all the elements in the array myList:

```

public class TestArray{

public static void main(String[] args){
double[] myList ={1.9,2.9,3.4,3.5};

// Print all the array elements
for(double element: myList){
System.out.println(element);
}
}
}

```

This would produce the following result:

```

1.9
2.9
3.4
3.5

```

Passing Arrays to Methods:

Just as you can pass primitive type values to methods, you can also pass arrays to methods. For example, the following method displays the elements in an int array:

```
public static void printArray(int[] array) {
    for(int i =0; i < array.length; i++){
        System.out.print(array[i]+" ");
    }
}
```

You can invoke it by passing an array. For example, the following statement invokes the printArray method to display 3, 1, 2, 6, 4, and 2:

```
printArray(newint[]{3,1,2,6,4,2});
```

Returning an Array from a Method:

A method may also return an array. For example, the method shown below returns an array that is the reversal of another array:

```
publicstaticint[] reverse(int[] list){
    int[] result =newint[list.length];

    for(int i =0, j = result.length -1; i < list.length; i++, j--){
        result[j]= list[i];
    }
    return result;
}
```

The Arrays Class:

The java.util.Arrays class contains various static methods for sorting and searching arrays, comparing arrays, and filling array elements. These methods are overloaded for all primitive types.

SN	Methods with Description
1	public static int binarySearch(Object[] a, Object key) Searches the specified array of Object (Byte, Int , double, etc.) for the specified value using the binary search algorithm. The array must be sorted prior to making this call. This returns index of the search key, if it is contained in the list; otherwise, -(insertion point + 1).
2	public static boolean equals(long[] a, long[] a2) Returns true if the two specified arrays of longs are equal to one another. Two arrays are considered equal if both arrays contain the same number of elements, and all corresponding pairs of elements in the two arrays are equal. This returns true if the two arrays are equal. Same method could be used by all other primitive data types (Byte, short, Int, etc.)
3	public static void fill(int[] a, int val) Assigns the specified int value to each element of the specified array of ints. Same method could be used by all other primitive data types (Byte, short, Int, etc.)
4	public static void sort(Object[] a) Sorts the specified array of objects into ascending order, according to the natural ordering of its elements. Same method could be used by all other primitive data types (Byte, short, Int, etc.)

Java Date and Time

Java provides the **Date** class available in **java.util** package, this class encapsulates the current date and time.

The Date class supports two constructors. The first constructor initializes the object with the current date and time.

```
Date ()
```

The following constructor accepts one argument that equals the number of milliseconds that have elapsed since midnight, January 1, 1970

```
Date(long millisec)
```

Once you have a Date object available, you can call any of the following support methods to play with dates:

SN	Methods with Description
1	boolean after(Date date) Returns true if the invoking Date object contains a date that is later than the one specified by date, otherwise, it returns false.
2	boolean before(Date date) Returns true if the invoking Date object contains a date that is earlier than the one specified by date, otherwise, it returns false.
3	Object clone() Duplicates the invoking Date object.
4	int compareTo(Date date) Compares the value of the invoking object with that of date. Returns 0 if the values are equal. Returns a negative value if the invoking object is earlier than date. Returns a positive value if the invoking object is later than date.
5	int compareTo(Object obj) Operates identically to compareTo(Date) if obj is of class Date. Otherwise, it throws a ClassCastException.
6	boolean equals(Object date) Returns true if the invoking Date object contains the same time and date as the one specified by date, otherwise, it returns false.
7	long getTime() Returns the number of milliseconds that have elapsed since January 1, 1970.

8	int hashCode() Returns a hash code for the invoking object.
9	void setTime(long time) Sets the time and date as specified by time, which represents an elapsed time in milliseconds from midnight, January 1, 1970
10	String toString() Converts the invoking Date object into a string and returns the result.

Getting Current Date & Time

This is very easy to get current date and time in Java. You can use a simple Date object with *toString()* method to print current date and time as follows:

```
import java.util.Date;

public class DateDemo{
public static void main(String args[]){
// Instantiate a Date object
Date date =newDate();

// display time and date using toString()
System.out.println(date.toString());
}
}
```

This would produce the following result:

```
MonMay0409:51:52 CDT 2009
```

Date Comparison:

There are following three ways to compare two dates:

- You can use `getTime()` to obtain the number of milliseconds that have elapsed since midnight, January 1, 1970, for both objects and then compare these two values.
- You can use the methods `before()`, `after()`, and `equals()`. Because the 12th of the month comes before the 18th, for example, `new Date(99, 2, 12).before(new Date (99, 2, 18))` returns true.
- You can use the `compareTo()` method, which is defined by the `Comparable` interface and implemented by `Date`.

Date Formatting using SimpleDateFormat:

`SimpleDateFormat` is a concrete class for formatting and parsing dates in a locale-sensitive manner. `SimpleDateFormat` allows you to start by choosing any user-defined patterns for date-time formatting. For example:

```
import java.util.*;
import java.text.*;

public class DateDemo{
public static void main(String args[]){

Date dNow =newDate();
```

```
SimpleDateFormat ft =
newSimpleDateFormat("E yyyy.MM.dd 'at' hh:mm:ss a zzz");

System.out.println("Current Date: "+ ft.format(dNow));
}
}
```

This would produce the following result:

```
CurrentDate:Sun2004.07.18 at 04:14:09 PM PDT
```

Simple DateFormat format codes:

To specify the time format, use a time pattern string. In this pattern, all ASCII letters are reserved as pattern letters, which are defined as the following:

Character	Description	Example
G	Era designator	AD
Y	Year in four digits	2001
M	Month in year	July or 07
D	Day in month	10
H	Hour in A.M./P.M. (1~12)	12
H	Hour in day (0~23)	22
M	Minute in hour	30
S	Second in minute	55
S	Millisecond	234
E	Day in week	Tuesday
D	Day in year	360
F	Day of week in month	2 (second Wed. in July)
W	Week in year	40
W	Week in month	1
A	A.M./P.M. marker	PM
K	Hour in day (1~24)	24
K	Hour in A.M./P.M. (0~11)	10
Z	Time zone	Eastern Standard Time
'	Escape for text	Delimiter
"	Single quote	`

Date Formatting using printf:

Date and time formatting can be done very easily using **printf** method. You use a two-letter format, starting with **t** and ending in one of the letters of the table given below. For example:

TUTORIALS POINT

Simply Easy Learning

```

import java.util.Date;

public class DateDemo{

public static void main(String args[]){
// Instantiate a Date object
Date date =new Date();

// display time and date using toString()
String str =String.format("Current Date/Time : %tc", date );

System.out.printf(str);
}
}

```

This would produce the following result:

```

CurrentDate/Time:SatDec1516:37:57 MST 2012

```

It would be a bit silly if you had to supply the date multiple times to format each part. For that reason, a format string can indicate the index of the argument to be formatted.

The index must immediately follow the % and it must be terminated by a \$. For example:

```

import java.util.Date;

public class DateDemo{

public static void main(String args[]){
// Instantiate a Date object
Date date =new Date();

// display time and date using toString()
System.out.printf("%1$s %2$tB %2$td, %2$tY",
"Due date:", date);
}
}

```

This would produce the following result:

```

Due date:February09,2004

```

Alternatively, you can use the < flag. It indicates that the same argument as in the preceding format specification should be used again. For example:

```

import java.util.Date;

public class DateDemo{

public static void main(String args[]){
// Instantiate a Date object
Date date =new Date();

// display formatted date
System.out.printf("%s %tB %<te, %<tY",
"Due date:", date);
}
}

```

This would produce the following result:

Due date: February 09, 2004

Date and Time Conversion Characters:

Character	Description	Example
c	Complete date and time	Mon May 04 09:51:52 CDT 2009
F	ISO 8601 date	2004-02-09
D	U.S. formatted date (month/day/year)	02/09/2004
T	24-hour time	18:05:19
r	12-hour time	06:05:19 pm
R	24-hour time, no seconds	18:05
Y	Four-digit year (with leading zeroes)	2004
y	Last two digits of the year (with leading zeroes)	04
C	First two digits of the year (with leading zeroes)	20
B	Full month name	February
b	Abbreviated month name	Feb
m	Two-digit month (with leading zeroes)	02
d	Two-digit day (with leading zeroes)	03
e	Two-digit day (without leading zeroes)	9
A	Full weekday name	Monday
a	Abbreviated weekday name	Mon
j	Three-digit day of year (with leading zeroes)	069
H	Two-digit hour (with leading zeroes), between 00 and 23	18
k	Two-digit hour (without leading zeroes), between 0 and 23	18
l	Two-digit hour (with leading zeroes), between 01 and 12	06
l	Two-digit hour (without leading zeroes), between 1 and 12	6
M	Two-digit minutes (with leading zeroes)	05
S	Two-digit seconds (with leading zeroes)	19
L	Three-digit milliseconds (with leading zeroes)	047
N	Nine-digit nanoseconds (with leading zeroes)	047000000
P	Uppercase morning or afternoon marker	PM
p	Lowercase morning or afternoon marker	pm
z	RFC 822 numeric offset from GMT	-0800

Z	Time zone	PST
s	Seconds since 1970-01-01 00:00:00 GMT	1078884319
Q	Milliseconds since 1970-01-01 00:00:00 GMT	1078884319047

There are other useful classes related to Date and time. For more details, you can refer to Java Standard documentation.

Parsing Strings into Dates:

The SimpleDateFormat class has some additional methods, notably parse() , which tries to parse a string according to the format stored in the given SimpleDateFormat object. For example:

```
import java.util.*;
import java.text.*;

public class DateDemo{

public static void main(String args[]){
SimpleDateFormat ft =new SimpleDateFormat("yyyy-MM-dd");

String input = args.length ==0?"1818-11-11": args[0];

System.out.print(input +" Parses as ");

Date t;

try{
    t = ft.parse(input);
System.out.println(t);
}catch(ParseException e){
System.out.println("Unparseable using "+ ft);
}
}
}
```

A sample run of the above program would produce the following result:

```
$ java DateDemo
1818-11-11ParsesasWedNov1100:00:00 GMT 1818
$ java DateDemo2007-12-01
2007-12-01ParsesasSatDec0100:00:00 GMT 2007
```

Sleeping for a While:

You can sleep for any period of time from one millisecond up to the lifetime of your computer. For example, following program would sleep for 10 seconds:

```
import java.util.*;

public class SleepDemo{
public static void main(String args[]){
try{
System.out.println(new Date()+"\n");
Thread.sleep(5*60*10);
System.out.println(new Date()+"\n");
}catch(Exception e){
System.out.println("Got an exception!");
}
}
```

```
}  
}  
}
```

This would produce the following result:

```
SunMay0318:04:41 GMT 2009  
SunMay0318:04:51 GMT 2009
```

Measuring Elapsed Time:

Sometimes, you may need to measure point in time in milliseconds. So let's rewrite above example once again:

```
import java.util.*;  
  
public class DiffDemo{  
  
    public static void main(String args[]){  
        try{  
            long start =System.currentTimeMillis();  
            System.out.println(new Date()+"\n");  
            Thread.sleep(5*60*10);  
            System.out.println(new Date()+"\n");  
                longend=System.currentTimeMillis();  
            long diff =end- start;  
            System.out.println("Difference is : "+ diff);  
        }catch(Exception e){  
            System.out.println("Got an exception!");  
        }  
    }  
}
```

This would produce the following result:

```
SunMay0318:16:51 GMT 2009  
SunMay0318:16:57 GMT 2009  
Differenceis:5993
```

GregorianCalendar Class:

GregorianCalendar is a concrete implementation of a Calendar class that implements the normal Gregorian calendar with which you are familiar. I did not discuss Calendar class in this tutorial, you can look standard Java documentation for this.

The **getInstance()** method of Calendar returns a GregorianCalendar initialized with the current date and time in the default locale and time zone. GregorianCalendar defines two fields: AD and BC. These represent the two eras defined by the Gregorian calendar.

There are also several constructors for GregorianCalendar objects:

SN	Constructor with Description
1	GregorianCalendar() Constructs a default GregorianCalendar using the current time in the default time zone with the default locale.
2	GregorianCalendar(int year, int month, int date)

	Constructs a <code>GregorianCalendar</code> with the given date set in the default time zone with the default locale.
3	<code>GregorianCalendar(int year, int month, int date, int hour, int minute)</code> Constructs a <code>GregorianCalendar</code> with the given date and time set for the default time zone with the default locale.
4	<code>GregorianCalendar(int year, int month, int date, int hour, int minute, int second)</code> Constructs a <code>GregorianCalendar</code> with the given date and time set for the default time zone with the default locale.
5	<code>GregorianCalendar(Locale aLocale)</code> Constructs a <code>GregorianCalendar</code> based on the current time in the default time zone with the given locale.
6	<code>GregorianCalendar(TimeZone zone)</code> Constructs a <code>GregorianCalendar</code> based on the current time in the given time zone with the default locale.
7	<code>GregorianCalendar(TimeZone zone, Locale aLocale)</code> Constructs a <code>GregorianCalendar</code> based on the current time in the given time zone with the given locale.

Here is the list of few useful support methods provided by `GregorianCalendar` class:

SN	Methods with Description
1	<code>void add(int field, int amount)</code> Adds the specified (signed) amount of time to the given time field, based on the calendar's rules.
2	<code>protected void computeFields()</code> Converts UTC as milliseconds to time field values.
3	<code>protected void computeTime()</code> Overrides <code>Calendar</code> Converts time field values to UTC as milliseconds.
4	<code>boolean equals(Object obj)</code> Compares this <code>GregorianCalendar</code> to an object reference.
5	<code>int get(int field)</code> Gets the value for a given time field.
6	<code>int getActualMaximum(int field)</code> Return the maximum value that this field could have, given the current date.
7	<code>int getActualMinimum(int field)</code> Return the minimum value that this field could have, given the current date.
8	<code>int getGreatestMinimum(int field)</code> Returns highest minimum value for the given field if varies.
9	<code>Date getGregorianChange()</code> Gets the Gregorian Calendar change date.
10	<code>int getLeastMaximum(int field)</code> Returns lowest maximum value for the given field if varies.
11	<code>int getMaximum(int field)</code> Returns maximum value for the given field.
12	<code>Date getTime()</code> Gets this <code>Calendar</code> 's current time.
13	<code>long getTimeInMillis()</code> Gets this <code>Calendar</code> 's current time as a long.

14	TimeZone getTimeZone() Gets the time zone.
15	int getMinimum(int field) Returns minimum value for the given field.
16	int hashCode() Override hashCode.
17	boolean isLeapYear(int year) Determines if the given year is a leap year.
18	void roll(int field, boolean up) Adds or subtracts (up/down) a single unit of time on the given time field without changing larger fields.
19	void set(int field, int value) Sets the time field with the given value.
20	void set(int year, int month, int date) Sets the values for the fields year, month, and date.
21	void set(int year, int month, int date, int hour, int minute) Sets the values for the fields year, month, date, hour, and minute.
22	void set(int year, int month, int date, int hour, int minute, int second) Sets the values for the fields year, month, date, hour, minute, and second.
23	void setGregorianChange(Date date) Sets the GregorianCalendar change date.
24	void setTime(Date date) Sets this Calendar's current time with the given Date.
25	void setTimeInMillis(long millis) Sets this Calendar's current time from the given long value.
26	void setTimeZone(TimeZone value) Sets the time zone with the given time zone value.
27	String toString() Return a string representation of this calendar.

Example:

```
import java.util.*;

public class GregorianCalendarDemo{

public static void main(String args[]){
String months[]={
"Jan", "Feb", "Mar", "Apr",
"May", "Jun", "Jul", "Aug",
"Sep", "Oct", "Nov", "Dec"};

int year;
// Create a Gregorian calendar initialized
// with the current date and time in the
// default locale and timezone.
GregorianCalendar gcalendar =new GregorianCalendar();
// Display current time and date information.
System.out.print("Date: ");
```

```
System.out.print(months[gcalendar.get(Calendar.MONTH)]);
System.out.print(" "+ gcalendar.get(Calendar.DATE)+" ");
System.out.println(year = gcalendar.get(Calendar.YEAR));
System.out.print("Time: ");
System.out.print(gcalendar.get(Calendar.HOUR)+":");
System.out.print(gcalendar.get(Calendar.MINUTE)+":");
System.out.println(gcalendar.get(Calendar.SECOND));

// Test if the current year is a leap year
if(gcalendar.isLeapYear(year)){
System.out.println("The current year is a leap year");
}
else{
System.out.println("The current year is not a leap year");
}
}
}
```

This would produce the following result:

```
Date:Apr222009
Time:11:25:27
The current year is not a leap year
```

For a complete list of constant available in Calendar class, you can refer to standard Java documentation.

Java Regular Expressions

Java provides the `java.util.regex` package for pattern matching with regular expressions. Java regular expressions are very similar to the Perl programming language and very easy to learn.

A regular expression is a special sequence of characters that helps you match or find other strings or sets of strings, using a specialized syntax held in a pattern. They can be used to search, edit, or manipulate text and data.

The `java.util.regex` package primarily consists of the following three classes:

- **Pattern Class:** A Pattern object is a compiled representation of a regular expression. The Pattern class provides no public constructors. To create a pattern, you must first invoke one of its public static compile methods, which will then return a Pattern object. These methods accept a regular expression as the first argument.
- **Matcher Class:** A Matcher object is the engine that interprets the pattern and performs match operations against an input string. Like the Pattern class, Matcher defines no public constructors. You obtain a Matcher object by invoking the `matcher` method on a Pattern object.
- **PatternSyntaxException:** A PatternSyntaxException object is an unchecked exception that indicates a syntax error in a regular expression pattern.

Capturing Groups:

Capturing groups are a way to treat multiple characters as a single unit. They are created by placing the characters to be grouped inside a set of parentheses. For example, the regular expression `(dog)` creates a single group containing the letters "d", "o", and "g".

Capturing groups are numbered by counting their opening parentheses from left to right. In the expression `((A)(B(C)))`, for example, there are four such groups:

- `((A)(B(C)))`
- `(A)`
- `(B(C))`
- `(C)`

To find out how many groups are present in the expression, call the `groupCount` method on a matcher object. The `groupCount` method returns an `int` showing the number of capturing groups present in the matcher's pattern.

TUTORIALS POINT

Simply Easy Learning

There is also a special group, group 0, which always represents the entire expression. This group is not included in the total reported by groupCount.

Example:

Following example illustrates how to find a digit string from the given alphanumeric string:

```
import java.util.regex.Matcher;
import java.util.regex.Pattern;

public class RegexMatches
{
    public static void main(String args[]){

        // String to be scanned to find the pattern.
        String line ="This order was places for QT3000! OK?";
        String pattern ="(.*) (\\d+) (.*)";

        // Create a Pattern object
        Pattern r =Pattern.compile(pattern);

        // Now create matcher object.
        Matcher m = r.matcher(line);
        if(m.find()){
            System.out.println("Found value: "+ m.group(0));
            System.out.println("Found value: "+ m.group(1));
            System.out.println("Found value: "+ m.group(2));
        }else{
            System.out.println("NO MATCH");
        }
    }
}
```

This would produce the following result:

```
Found value:This order was places for QT3000! OK?
Found value:This order was places for QT300
Found value:0
```

Regular Expression Syntax:

Here is the table listing down all the regular expression metacharacter syntax available in Java:

Subexpression	Matches
^	Matches beginning of line.
\$	Matches end of line.
.	Matches any single character except newline. Using m option allows it to match newline as well.
[...]	Matches any single character in brackets.
[^...]	Matches any single character not in brackets
\A	Beginning of entire string
\Z	End of entire string
\Z	End of entire string except allowable final line terminator.

<code>re*</code>	Matches 0 or more occurrences of preceding expression.
<code>re+</code>	Matches 1 or more of the previous thing
<code>re?</code>	Matches 0 or 1 occurrence of preceding expression.
<code>re{ n}</code>	Matches exactly n number of occurrences of preceding expression.
<code>re{ n,}</code>	Matches n or more occurrences of preceding expression.
<code>re{ n, m}</code>	Matches at least n and at most m occurrences of preceding expression.
<code>a b</code>	Matches either a or b.
<code>(re)</code>	Groups regular expressions and remembers matched text.
<code>(?: re)</code>	Groups regular expressions without remembering matched text.
<code>(?> re)</code>	Matches independent pattern without backtracking.
<code>\w</code>	Matches word characters.
<code>\W</code>	Matches nonword characters.
<code>\s</code>	Matches whitespace. Equivalent to <code>[\t\n\r\f]</code> .
<code>\S</code>	Matches nonwhitespace.
<code>\d</code>	Matches digits. Equivalent to <code>[0-9]</code> .
<code>\D</code>	Matches nondigits.
<code>\A</code>	Matches beginning of string.
<code>\Z</code>	Matches end of string. If a newline exists, it matches just before newline.
<code>\z</code>	Matches end of string.
<code>\G</code>	Matches point where last match finished.
<code>\n</code>	Back-reference to capture group number "n"
<code>\b</code>	Matches word boundaries when outside brackets. Matches backspace (0x08) when inside brackets.
<code>\B</code>	Matches nonword boundaries.
<code>\n, \t, etc.</code>	Matches newlines, carriage returns, tabs, etc.
<code>\Q</code>	Escape (quote) all characters up to <code>\E</code>
<code>\E</code>	Ends quoting begun with <code>\Q</code>

Methods of the Matcher Class:

Here is a list of useful instance methods:

Index Methods:

Index methods provide useful index values that show precisely where the match was found in the input string:

SN	Methods with Description
----	--------------------------

TUTORIALS POINT

Simply Easy Learning

1	public int start() Returns the start index of the previous match.
2	public int start(int group) Returns the start index of the subsequence captured by the given group during the previous match operation.
3	public int end() Returns the offset after the last character matched.
4	public int end(int group) Returns the offset after the last character of the subsequence captured by the given group during the previous match operation.

Study Methods:

Study methods review the input string and return a Boolean indicating whether or not the pattern is found:

SN	Methods with Description
1	public boolean lookingAt() Attempts to match the input sequence, starting at the beginning of the region, against the pattern.
2	public boolean find() Attempts to find the next subsequence of the input sequence that matches the pattern.
3	public boolean find(int start) Resets this matcher and then attempts to find the next subsequence of the input sequence that matches the pattern, starting at the specified index.
4	public boolean matches() Attempts to match the entire region against the pattern.

Replacement Methods:

Replacement methods are useful methods for replacing text in an input string:

SN	Methods with Description
1	public Matcher appendReplacement(StringBuffer sb, String replacement) Implements a non-terminal append-and-replace step.
2	public StringBuffer appendTail(StringBuffer sb) Implements a terminal append-and-replace step.
3	public String replaceAll(String replacement) Replaces every subsequence of the input sequence that matches the pattern with the given replacement string.
4	public String replaceFirst(String replacement) Replaces the first subsequence of the input sequence that matches the pattern with the given replacement string.
5	public static String quoteReplacement(String s) Returns a literal replacement String for the specified String. This method produces a String that will work as a literal replacement s in the appendReplacement method of the Matcher class.

The start and end Methods:

Following is the example that counts the number of times the word "cats" appears in the input string:

```
import java.util.regex.Matcher;
import java.util.regex.Pattern;

public class RegexMatches
{
    private static final String REGEX = "\\bcat\\b";
    private static final String INPUT = "cat cat cat cattie cat";

    public static void main(String args[]){
        Pattern p =Pattern.compile(REGEX);
        Matcher m = p.matcher(INPUT);// get a matcher object
        int count =0;

        while(m.find()){
            count++;
            System.out.println("Match number "+count);
            System.out.println("start(): "+m.start());
            System.out.println("end(): "+m.end());
        }
    }
}
```

This would produce the following result:

```
Match number 1
start():0
end():3
Match number 2
start():4
end():7
Match number 3
start():8
end():11
Match number 4
start():19
end():22
```

You can see that this example uses word boundaries to ensure that the letters "c" "a" "t" are not merely a substring in a longer word. It also gives some useful information about where in the input string the match has occurred.

The start method returns the start index of the subsequence captured by the given group during the previous match operation, and end returns the index of the last character matched, plus one.

The *matches* and *lookingAt* Methods:

The matches and lookingAt methods both attempt to match an input sequence against a pattern. The difference, however, is that matches requires the entire input sequence to be matched, while lookingAt does not.

Both methods always start at the beginning of the input string. Here is the example explaining the functionality:

```
import java.util.regex.Matcher;
import java.util.regex.Pattern;

public class RegexMatches
{
```

TUTORIALS POINT

Simply Easy Learning

```

private static final String REGEX = "foo";
private static final String INPUT = "fooooooooooooooooooooo";
private static Pattern pattern;
private static Matcher matcher;

public static void main(String args[]){
    pattern =Pattern.compile(REGEX);
    matcher = pattern.matcher(INPUT);

    System.out.println("Current REGEX is: "+REGEX);
    System.out.println("Current INPUT is: "+INPUT);

    System.out.println("lookingAt(): "+matcher.lookingAt());
    System.out.println("matches(): "+matcher.matches());
}
}

```

This would produce the following result:

```

Current REGEX is: foo
Current INPUT is: foooooooooooooooooooo
lookingAt():true
matches():false

```

The *replaceFirst* and *replaceAll* Methods:

The `replaceFirst` and `replaceAll` methods replace text that matches a given regular expression. As their names indicate, `replaceFirst` replaces the first occurrence, and `replaceAll` replaces all occurrences.

Here is the example explaining the functionality:

```

import java.util.regex.Matcher;
import java.util.regex.Pattern;

public class RegexMatches
{
    private static String REGEX ="dog";
    private static String INPUT ="The dog says meow. "+ "All dogs say meow.";
    private static String REPLACE ="cat";

    public static void main(String[] args){
        Pattern p =Pattern.compile(REGEX);
        // get a matcher object
        Matcher m = p.matcher(INPUT);
        INPUT = m.replaceAll(REPLACE);
        System.out.println(INPUT);
    }
}

```

This would produce the following result:

```

The cat says meow.All cats say meow.

```

The *appendReplacement* and *appendTail* Methods:

The `Matcher` class also provides `appendReplacement` and `appendTail` methods for text replacement.

Here is the example explaining the functionality:

```

import java.util.regex.Matcher;

```



```

import java.util.regex.Pattern;

public class RegexMatches
{
private static String REGEX ="a*b";
private static String INPUT ="aabfooaabfooabfoob";
private static String REPLACE ="-";
public static void main(String[] args){
Pattern p =Pattern.compile(REGEX);
// get a matcher object
Matcher m = p.matcher(INPUT);
StringBuffer sb =new StringBuffer();
while(m.find()){
m.appendReplacement (sb,REPLACE);
}
m.appendTail (sb);
System.out.println(sb.toString());
}
}

```

This would produce the following result:

```
-foo-foo-foo-
```

PatternSyntaxException Class Methods:

A PatternSyntaxException is an unchecked exception that indicates a syntax error in a regular expression pattern. The PatternSyntaxException class provides the following methods to help you determine what went wrong:

SN	Methods with Description
1	public String getDescription() Retrieves the description of the error.
2	public int getIndex() Retrieves the error index.
3	public String getPattern() Retrieves the erroneous regular expression pattern.
4	public String getMessage() Returns a multi-line string containing the description of the syntax error and its index, the erroneous regular expression pattern, and a visual indication of the error index within the pattern.

Java Methods

A **Javamethod** is a collection of statements that are grouped together to perform an operation. When you call the `System.out.println` method, for example, the system actually executes several statements in order to display a message on the console.

Now you will learn how to create your own methods with or without return values, invoke a method with or without parameters, overload methods using the same names, and apply method abstraction in the program design.

Creating a Method:

In general, a method has the following syntax:

```
modifier returnType methodName(list of parameters) {  
    // Method body;  
}
```

A method definition consists of a method header and a method body. Here are all the parts of a method:

- **Modifiers:** The modifier, which is optional, tells the compiler how to call the method. This defines the access type of the method.
- **Return Type:** A method may return a value. The `returnValueType` is the data type of the value the method returns. Some methods perform the desired operations without returning a value. In this case, the `returnValueType` is the keyword `void`.
- **Method Name:** This is the actual name of the method. The method name and the parameter list together constitute the method signature.
- **Parameters:** A parameter is like a placeholder. When a method is invoked, you pass a value to the parameter. This value is referred to as actual parameter or argument. The parameter list refers to the type, order, and number of the parameters of a method. Parameters are optional; that is, a method may contain no parameters.
- **Method Body:** The method body contains a collection of statements that define what the method does.

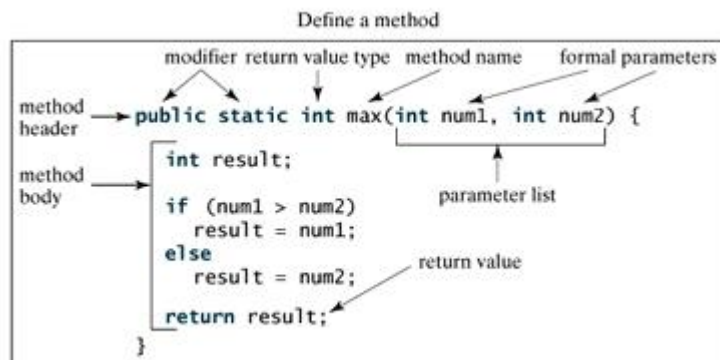

Note: In certain other languages, methods are referred to as procedures and functions. A method with a nonvoid return value type is called a function; a method with a void return value type is called a procedure.

Example:

Here is the source code of the above defined method called `max()`. This method takes two parameters `num1` and `num2` and returns the maximum between the two:

```
/** Return the max between two numbers */
public static int max(int num1, int num2) {
    int result;
    if(num1 > num2)
        result = num1;
    else
        result = num2;

    return result;
}
```

Calling a Method:

In creating a method, you give a definition of what the method is to do. To use a method, you have to call or invoke it. There are two ways to call a method; the choice is based on whether the method returns a value or not.

When a program calls a method, program control is transferred to the called method. A called method returns control to the caller when its return statement is executed or when its method-ending closing brace is reached.

If the method returns a value, a call to the method is usually treated as a value. For example:

```
int larger = max(30, 40);
```

If the method returns void, a call to the method must be a statement. For example, the method `println` returns void. The following call is a statement:

```
System.out.println("Welcome to Java!");
```

Example:

Following is the example to demonstrate how to define a method and how to call it:

```
public class TestMax{
    /** Main method */
    public static void main(String[] args){
```

```

int i =5;
int j =2;
int k = max(i, j);
System.out.println("The maximum between "+ i +
" and "+ j +" is "+ k);
}

/** Return the max between two numbers */
public static int max(int num1,int num2){
int result;
if(num1 > num2)
result = num1;
else
    result = num2;

return result;
}
}

```

This would produce the following result:

```
The maximum between 5and2is5
```

This program contains the main method and the max method. The main method is just like any other method except that it is invoked by the JVM.

The main method's header is always the same, like the one in this example, with the modifiers public and static, return value type void, method name main, and a parameter of the String[] type. String[] indicates that the parameter is an array of String.

The void Keyword:

This section shows how to declare and invoke a void method. Following example gives a program that declares a method named printGrade and invokes it to print the grade for a given score.

Example:

```

public class TestVoidMethod{

public static void main(String[] args){
printGrade(78.5);
}

public static void printGrade(double score){
if(score >=90.0){
System.out.println('A');
}
elseif(score >=80.0){
System.out.println('B');
}
elseif(score >=70.0){
System.out.println('C');
}
elseif(score >=60.0){
System.out.println('D');
}
else{
System.out.println('F');
}
}
}

```

```
}  
}
```

This would produce the following result:

```
C
```

Here the printGrade method is a void method. It does not return any value. A call to a void method must be a statement. So, it is invoked as a statement in line 3 in the main method. This statement is like any Java statement terminated with a semicolon.

Passing Parameters by Values:

When calling a method, you need to provide arguments, which must be given in the same order as their respective parameters in the method specification. This is known as parameter order association.

For example, the following method prints a message n times:

```
public static void nPrintln(String message, int n){  
    for(int i =0; i < n; i++)  
        System.out.println(message);  
}
```

Here, you can use nPrintln("Hello", 3) to print "Hello" three times. The nPrintln("Hello", 3) statement passes the actual string parameter, "Hello", to the parameter, message; passes 3 to n; and prints "Hello" three times. However, the statement nPrintln(3, "Hello") would be wrong.

When you invoke a method with a parameter, the value of the argument is passed to the parameter. This is referred to as pass-by-value. If the argument is a variable rather than a literal value, the value of the variable is passed to the parameter. The variable is not affected, regardless of the changes made to the parameter inside the method.

For simplicity, Java programmers often say passing an argument x to a parameter y, which actually means passing the value of x to y.

Example:

Following is a program that demonstrates the effect of passing by value. The program creates a method for swapping two variables. The swap method is invoked by passing two arguments. Interestingly, the values of the arguments are not changed after the method is invoked.

```
public class TestPassByValue{  
  
    public static void main(String[] args){  
        int num1 =1;  
        int num2 =2;  
  
        System.out.println("Before swap method, num1 is "+num1 +" and num2 is "+ num2);  
  
        // Invoke the swap method  
        swap(num1, num2);  
        System.out.println("After swap method, num1 is "+num1 +" and num2 is "+ num2);  
    }  
    /** Method to swap two variables */  
    public static void swap(int n1,int n2){  
        System.out.println("\t\tInside the swap method");  
        System.out.println("\t\t\tBefore swapping n1 is "+ n1+" n2 is "+ n2);  
        // Swap n1 with n2  
        int temp = n1;
```

```
n1 = n2;
n2 = temp;

System.out.println("\t\tAfter swapping n1 is "+ n1+" n2 is "+ n2);
}
}
```

This would produce the following result:

```
Before swap method, num1 is1and num2 is2
Inside the swap method
Before swapping n1 is1 n2 is2
After swapping n1 is2 n2 is1
After swap method, num1 is1and num2 is2
```

Overloading Methods:

The max method that was used earlier works only with the int data type. But what if you need to find which of two floating-point numbers has the maximum value? The solution is to create another method with the same name but different parameters, as shown in the following code:

```
public static double max(double num1, double num2) {
    if(num1 > num2)
        return num1;
    else
        return num2;
}
```

If you call max with int parameters, the max method that expects int parameters will be invoked; if you call max with double parameters, the max method that expects double parameters will be invoked. This is referred to as **method overloading**; that is, two methods have the same name but different parameter lists within one class.

The Java compiler determines which method is used based on the method signature. Overloading methods can make programs clearer and more readable. Methods that perform closely related tasks should be given the same name.

Overloaded methods must have different parameter lists. You cannot overload methods based on different modifiers or return types. Sometimes there are two or more possible matches for an invocation of a method due to similar method signature, so the compiler cannot determine the most specific match. This is referred to as ambiguous invocation.

The Scope of Variables:

The scope of a variable is the part of the program where the variable can be referenced. A variable defined inside a method is referred to as a local variable.

The scope of a local variable starts from its declaration and continues to the end of the block that contains the variable. A local variable must be declared before it can be used.

A parameter is actually a local variable. The scope of a method parameter covers the entire method.

A variable declared in the initial action part of a for loop header has its scope in the entire loop. But a variable declared inside a for loop body has its scope limited in the loop body from its declaration to the end of the block that contains the variable as shown below:

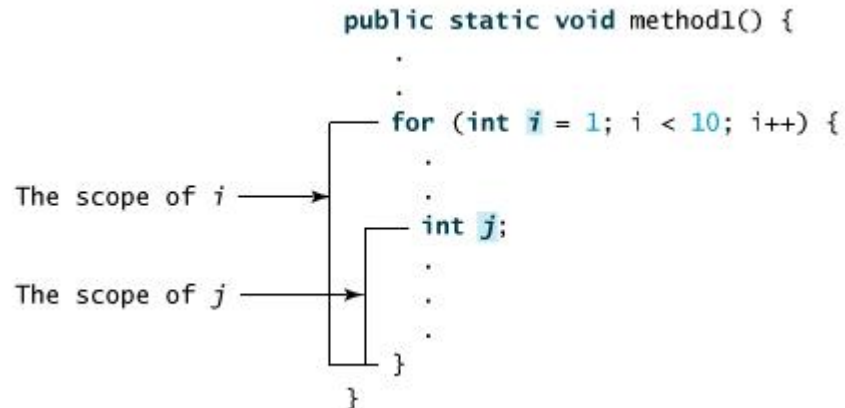

You can declare a local variable with the same name multiple times in different non-nesting blocks in a method, but you cannot declare a local variable twice in nested blocks.

Using Command-Line Arguments:

Sometimes you will want to pass information into a program when you run it. This is accomplished by passing command-line arguments to `main()`.

A command-line argument is the information that directly follows the program's name on the command line when it is executed. To access the command-line arguments inside a Java program is quite easy. They are stored as strings in the `String` array passed to `main()`.

Example:

The following program displays all of the command-line arguments that it is called with:

```

public class CommandLine{

public static void main(String args[]){
for(int i=0; i<args.length; i++){
System.out.println("args["+ i +"]: "+args[i]);
}
}
}

```

Try executing this program as shown here:

```

java CommandLine this is a command line 200-100

```

This would produce the following result:

```

args[0]:this
args[1]:is
args[2]: a
args[3]: command
args[4]: line
args[5]:200
args[6]:-100

```

The Constructors:

A constructor initializes an object when it is created. It has the same name as its class and is syntactically similar to a method. However, constructors have no explicit return type.

Typically, you will use a constructor to give initial values to the instance variables defined by the class, or to perform any other startup procedures required to create a fully formed object.

All classes have constructors, whether you define one or not, because Java automatically provides a default constructor that initializes all member variables to zero. However, once you define your own constructor, the default constructor is no longer used.

Example:

Here is a simple example that uses a constructor:

```
// A simple constructor.
class MyClass{
    int x;

    // Following is the constructor
    MyClass(){
        x =10;
    }
}
```

You would call constructor to initialize objects as follows:

```
public class ConsDemo{

    public static void main(String args[]){
        MyClass t1 =new MyClass();
        MyClass t2 =new MyClass();
        System.out.println(t1.x +" "+ t2.x);
    }
}
```

Most often, you will need a constructor that accepts one or more parameters. Parameters are added to a constructor in the same way that they are added to a method, just declare them inside the parentheses after the constructor's name.

Example:

Here is a simple example that uses a constructor:

```
// A simple constructor.
class MyClass{
    int x;

    // Following is the constructor
    MyClass(int i ){
        x = i;
    }
}
```

You would call constructor to initialize objects as follows:

```
public class ConsDemo{
```



```
public static void main(String args[]){
    MyClass t1 =new MyClass(10);
    MyClass t2 =new MyClass(20);
    System.out.println(t1.x +" "+ t2.x);
}
}
```

This would produce the following result:

```
1020
```

Variable Arguments(var-args):

JDK 1.5 enables you to pass a variable number of arguments of the same type to a method. The parameter in the method is declared as follows:

```
typeName... parameterName
```

In the method declaration, you specify the type followed by an ellipsis (...). Only one variable-length parameter may be specified in a method, and this parameter must be the last parameter. Any regular parameters must precede it.

Example:

```
public class VarargsDemo{

    public static void main(String args[]){
        // Call method with variable args
        printMax(34,3,3,2,56.5);
        printMax(new double[]{1,2,3});
    }

    public static void printMax(double... numbers){
        if(numbers.length ==0){
            System.out.println("No argument passed");
            return;
        }

        double result = numbers[0];

        for(int i =1; i < numbers.length; i++){
            if(numbers[i]> result)
                result = numbers[i];
        }
        System.out.println("The max value is "+ result);
    }
}
```

This would produce the following result:

```
The max value is 56.5
The max value is 3.0
```

The finalize() Method:

It is possible to define a method that will be called just before an object's final destruction by the garbage collector. This method is called **finalize()**, and it can be used to ensure that an object terminates cleanly.

For example, you might use `finalize()` to make sure that an open file owned by that object is closed.

TUTORIALS POINT

Simply Easy Learning

To add a finalizer to a class, you simply define the `finalize()` method. The Java runtime calls that method whenever it is about to recycle an object of that class.

Inside the `finalize()` method, you will specify those actions that must be performed before an object is destroyed.

The `finalize()` method has this general form:

```
protected void finalize()  
{  
    // finalization code here  
}
```

Here, the keyword `protected` is a specifier that prevents access to `finalize()` by code defined outside its class.

This means that you cannot know when or even if `finalize()` will be executed. For example, if your program ends before garbage collection occurs, `finalize()` will not execute.

Java Streams, Files and I/O

The `java.io` package contains nearly every class you might ever need to perform input and output (I/O) in Java. All these streams represent an input source and an output destination. The stream in the `java.io` package supports many data such as primitives, Object, localized characters, etc.

A stream can be defined as a sequence of data. The `InputStream` is used to read data from a source and the `OutputStream` is used for writing data to a destination.

Java provides strong but flexible support for I/O related to Files and networks but this tutorial covers very basic functionality related to streams and I/O. We would see most commonly used example one by one:

Byte Streams

Java byte streams are used to perform input and output of 8-bit bytes. Though there are many classes related to byte streams but the most frequently used classes are `FileInputStream` and `FileOutputStream`. Following is an example which makes use of these two classes to copy an input file into an output file:

```
import java.io.*;

public class CopyFile {
    public static void main(String args[]) throws IOException
    {
        FileInputStream in = null;
        FileOutputStream out = null;

        try {
            in = new FileInputStream("input.txt");
            out = new FileOutputStream("output.txt");

            int c;
            while ((c = in.read()) != -1) {
                out.write(c);
            }
        } finally {
            if (in != null) {
                in.close();
            }
            if (out != null) {
                out.close();
            }
        }
    }
}
```

TUTORIALS POINT

Simply Easy Learning

```
}  
}
```

Now let's have a file **input.txt** with the following content:

```
This is test for copy file.
```

As a next step, compile above program and execute it, which will result in creating output.txt file with the same content as we have in input.txt. So let's put above code in CopyFile.java file and do the following:

```
$javac CopyFile.java  
$java CopyFile
```

Character Streams

Java **Byte** streams are used to perform input and output of 8-bit bytes, where as Java **Character** streams are used to perform input and output for 16-bit unicode. Though there are many classes related to character streams but the most frequently used classes are **FileReader** and **FileWriter**. Though internally **FileReader** uses **FileInputStream** and **FileWriter** uses **FileOutputStream** but here major difference is that **FileReader** reads two bytes at a time and **FileWriter** writes two bytes at a time.

We can re-write above example which makes use of these two classes to copy an input file (having unicode characters) into an output file:

```
import java.io.*;  
  
public class CopyFile {  
    public static void main(String args[]) throws IOException  
    {  
        FileReader in = null;  
        FileWriter out = null;  
  
        try {  
            in = new FileReader("input.txt");  
            out = new FileWriter("output.txt");  
  
            int c;  
            while ((c = in.read()) != -1) {  
                out.write(c);  
            }  
        } finally {  
            if (in != null) {  
                in.close();  
            }  
            if (out != null) {  
                out.close();  
            }  
        }  
    }  
}
```

Now let's have a file **input.txt** with the following content:

```
This is test for copy file.
```

As a next step, compile above program and execute it, which will result in creating output.txt file with the same content as we have in input.txt. So let's put above code in CopyFile.java file and do the following:

```
$javac CopyFile.java
```

```
$java CopyFile
```

Standard Streams

All the programming languages provide support for standard I/O where user's program can take input from a keyboard and then produce output on the computer screen. If you are aware if C or C++ programming languages, then you must be aware of three standard devices STDIN, STDOUT and STDERR. Similar way Java provides following three standard streams

- **Standard Input:** This is used to feed the data to user's program and usually a keyboard is used as standard input stream and represented as **System.in**.
- **Standard Output:** This is used to output the data produced by the user's program and usually a computer screen is used to standard output stream and represented as **System.out**.
- **Standard Error:** This is used to output the error data produced by the user's program and usually a computer screen is used to standard error stream and represented as **System.err**.

Following is a simple program which creates **InputStreamReader** to read standard input stream until the user types a "q":

```
import java.io.*;

public class ReadConsole {
    public static void main(String args[]) throws IOException
    {
        InputStreamReader cin = null;

        try {
            cin = new InputStreamReader(System.in);
            System.out.println("Enter characters, 'q' to quit.");
            char c;
            do {
                c = (char) cin.read();
                System.out.print(c);
            } while(c != 'q');
        } finally {
            if (cin != null) {
                cin.close();
            }
        }
    }
}
```

Let's keep above code in ReadConsole.java file and try to compile and execute it as below. This program continues reading and outputting same character until we press 'q':

```
$javac ReadConsole.java
$java ReadConsole
Enter characters, 'q' to quit.
l
l
e
e
q
q
```

Reading and Writing Files:

As described earlier, A stream can be defined as a sequence of data. The **InputStream** is used to read data from a source and the **OutputStream** is used for writing data to a destination.

Here is a hierarchy of classes to deal with Input and Output streams.

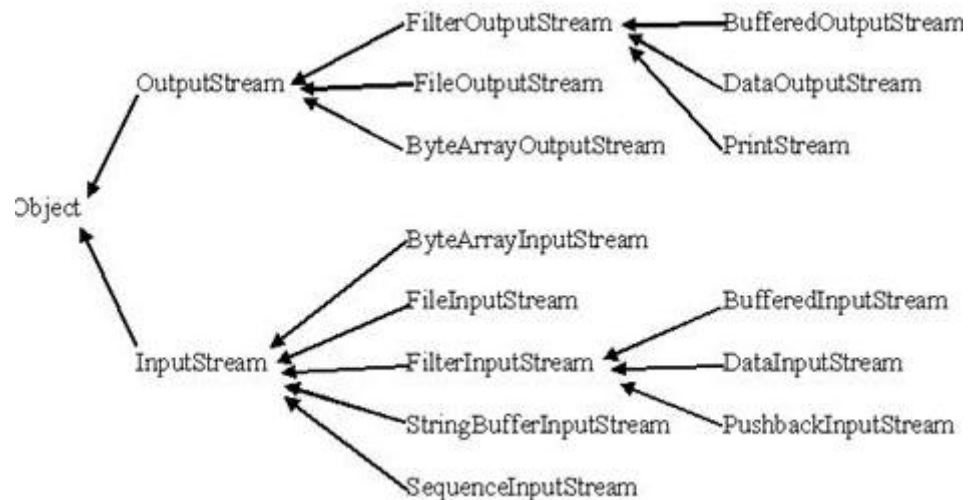

The two important streams are **FileInputStream** and **FileOutputStream**, which would be discussed in this tutorial:

FileInputStream:

This stream is used for reading data from the files. Objects can be created using the keyword `new` and there are several types of constructors available.

Following constructor takes a file name as a string to create an input stream object to read the file.:

```
InputStream f = new FileInputStream("C:/java/hello");
```

Following constructor takes a file object to create an input stream object to read the file. First we create a file object using `File()` method as follows:

```
File f = new File("C:/java/hello");  
InputStream f = new FileInputStream(f);
```

Once you have `InputStream` object in hand, then there is a list of helper methods which can be used to read to stream or to do other operations on the stream.

SN	Methods with Description
1	public void close() throws IOException{ This method closes the file output stream. Releases any system resources associated with the file. Throws an <code>IOException</code> .
2	protected void finalize()throws IOException { This method cleans up the connection to the file. Ensures that the close method of this file output stream is called when there are no more references to this stream. Throws an <code>IOException</code> .
3	public int read(int r)throws IOException{

	This method reads the specified byte of data from the InputStream. Returns an int. Returns the next byte of data and -1 will be returned if it's end of file.
4	public int read(byte[] r) throws IOException{ This method reads r.length bytes from the input stream into an array. Returns the total number of bytes read. If end of file -1 will be returned.
5	public int available() throws IOException{ Gives the number of bytes that can be read from this file input stream. Returns an int.

There are other important input streams available, for more detail you can refer to the following links:

- [ByteArrayInputStream](#)
- [DataInputStream](#)

ByteArrayInputStream

The `ByteArrayInputStream` class allows a buffer in the memory to be used as an `InputStream`. The input source is a byte array. There are following forms of constructors to create `ByteArrayInputStream` objects

Takes a byte array as the parameter:

```
ByteArrayInputStream bArray = new ByteArrayInputStream(byte [] a);
```

Another form takes an array of bytes, and two ints, where **off** is the first byte to be read and **len** is the number of bytes to be read.

```
ByteArrayInputStream bArray = new ByteArrayInputStream(byte []a,
                                                    int off,
                                                    int len)
```

Once you have `ByteArrayInputStream` object in hand then there is a list of helper methods which can be used to read the stream or to do other operations on the stream.

SN	Methods with Description
1	public int read() This method reads the next byte of data from the <code>InputStream</code> . Returns an int as the next byte of data. If it is end of file then it returns -1.
2	public int read(byte[] r, int off, int len) This method reads upto len number of bytes starting from off from the input stream into an array. Returns the total number of bytes read. If end of file -1 will be returned.
3	public int available() Gives the number of bytes that can be read from this file input stream. Returns an int that gives the number of bytes to be read.
4	public void mark(int read) This sets the current marked position in the stream. The parameter gives the maximum limit of bytes that can be read before the marked position becomes invalid.
5	public long skip(long n) Skips n number of bytes from the stream. This returns the actual number of bytes skipped.

Example:

Following is the example to demonstrate `ByteArrayInputStream` and `ByteArrayOutputStream`

```

import java.io.*;

public class ByteStreamTest {

    public static void main(String args[])throws IOException {

        ByteArrayOutputStream bOutput = new ByteArrayOutputStream(12);

        while( bOutput.size() != 10 ) {
            // Gets the inputs from the user
            bOutput.write(System.in.read());
        }

        byte b [] = bOutput.toByteArray();
        System.out.println("Print the content");
        for(int x= 0 ; x < b.length; x++) {
            // printing the characters
            System.out.print((char)b[x] + " ");
        }
        System.out.println("\n");

        int c;

        ByteArrayInputStream bInput = new ByteArrayInputStream(b);

        System.out.println("Converting characters to Upper case ");
        for(int y = 0 ; y < 1; y++ ) {
            while(( c= bInput.read()) != -1) {
                System.out.println(Character.toUpperCase((char)c));
            }
            bInput.reset();
        }
    }
}

```

Here is the sample run of the above program:

```

asdfghjkl y
Print the content
a s d f g h j k l y
Converting characters to Upper case
A
S
D
F
G
H
J
K
L
Y

```

DataInputStream

The DataInputStream is used in the context of DataOutputStream and can be used to read primitives.

Following is the constructor to create an InputStream:

```

InputStream in = DataInputStream(InputStream in);

```

TUTORIALS POINT

Simply Easy Learning

Once you have *DataInputStream* object in hand, then there is a list of helper methods, which can be used to read the stream or to do other operations on the stream.

SN	Methods with Description
1	public final int read(byte[] r, int off, int len) throws IOException Reads up to len bytes of data from the input stream into an array of bytes. Returns the total number of bytes read into the buffer otherwise -1 if it is end of file.
2	Public final int read(byte [] b) throws IOException Reads some bytes from the inputstream an stores in to the byte array. Returns the total number of bytes read into the buffer otherwise -1 if it is end of file.
3	(a) public final Boolean readBooolean() throws IOException, (b) public final byte readByte() throws IOException, (c) public final short readShort() throws IOException (d) public final Int readInt() throws IOException These methods will read the bytes from the contained InputStream. Returns the next two bytes of the InputStream as the specific primitive type.
4	public String readLine() throws IOException Reads the next line of text from the input stream. It reads successive bytes, converting each byte separately into a character, until it encounters a line terminator or end of file; the characters read are then returned as a String.

Example:

Following is the example to demonstrate *DataInputStream* and *DataOutputStream*. This example reads 5 lines given in a file *test.txt* and convert those lines into capital letters and finally copies them into another file *test1.txt*.

```
import java.io.*;

public class Test{
    public static void main(String args[]) throws IOException{

        DataInputStream d = new DataInputStream(new
            FileInputStream("test.txt"));

        DataOutputStream out = new DataOutputStream(new
            FileOutputStream("test1.txt"));

        String count;
        while((count = d.readLine()) != null){
            String u = count.toUpperCase();
            System.out.println(u);
            out.writeBytes(u + " ,");
        }
        d.close();
        out.close();
    }
}
```

Here is the sample run of the above program:

```
THIS IS TEST 1 ,
THIS IS TEST 2 ,
THIS IS TEST 3 ,
THIS IS TEST 4 ,
THIS IS TEST 5 ,
```

FileOutputStream:

FileOutputStream is used to create a file and write data into it. The stream would create a file, if it doesn't already exist, before opening it for output.

Here are two constructors which can be used to create a FileOutputStream object.

Following constructor takes a file name as a string to create an input stream object to write the file:

```
OutputStream f = new FileOutputStream("C:/java/hello")
```

Following constructor takes a file object to create an output stream object to write the file. First, we create a file object using File() method as follows:

```
File f = new File("C:/java/hello");  
OutputStream f = new FileOutputStream(f);
```

Once you have *OutputStream* object in hand, then there is a list of helper methods, which can be used to write to stream or to do other operations on the stream.

SN	Methods with Description
1	public void close() throws IOException{} This method closes the file output stream. Releases any system resources associated with the file. Throws an IOException.
2	protected void finalize()throws IOException {} This method cleans up the connection to the file. Ensures that the close method of this file output stream is called when there are no more references to this stream. Throws an IOException.
3	public void write(int w)throws IOException{} This methods writes the specified byte to the output stream.
4	public void write(byte[] w) Writes w.length bytes from the mentioned byte array to the OutputStream.

There are other important output streams available, for more detail you can refer to the following links:

- [ByteArrayOutputStream](#)
- [DataOutputStream](#)

ByteArrayOutputStream

The ByteArrayOutputStream class stream creates a buffer in memory and all the data sent to the stream is stored in the buffer. There are following forms of constructors to create ByteArrayOutputStream objects

Following constructor creates a buffer of 32 byte:

```
OutputStream bOut = new ByteArrayOutputStream()
```

Following constructor creates a buffer of size int a:

```
OutputStream bOut = new ByteArrayOutputStream(int a)
```

Once you have *ByteArrayOutputStream* object in hand then there is a list of helper methods which can be used to write the stream or to do other operations on the stream.

SN	Methods with Description
1	public void reset() This method resets the number of valid bytes of the byte array output stream to zero, so all the accumulated output in the stream will be discarded.
2	public byte[] toByteArray() This method creates a newly allocated Byte array. Its size would be the current size of the output stream and the contents of the buffer will be copied into it. Returns the current contents of the output stream as a byte array.
3	public String toString() Converts the buffer content into a string. Translation will be done according to the default character encoding. Returns the String translated from the buffer's content.
4	public void write(int w) Writes the specified array to the output stream.
5	public void write(byte []b, int of, int len) Writes len number of bytes starting from offset off to the stream.
6	public void writeTo(OutputStream outSt) Writes the entire content of this Stream to the specified stream argument.

Example:

Following is the example to demonstrate ByteArrayOutputStream and ByteArrayInputStream

```
import java.io.*;

public class ByteStreamTest {

    public static void main(String args[])throws IOException {

        ByteArrayOutputStream bOutput = new ByteArrayOutputStream(12);

        while( bOutput.size() != 10 ) {
            // Gets the inputs from the user
            bOutput.write(System.in.read());
        }

        byte b [] = bOutput.toByteArray();
        System.out.println("Print the content");
        for(int x = 0 ; x < b.length; x++) {
            //printing the characters
            System.out.print((char)b[x] + " ");
        }
        System.out.println(" ");

        int c;

        ByteArrayInputStream bInput = new ByteArrayInputStream(b);

        System.out.println("Converting characters to Upper case ");
        for(int y = 0 ; y < 1; y++ ) {
            while(( c= bInput.read()) != -1) {
                System.out.println(Character.toUpperCase((char)c));
            }
            bInput.reset();
        }
    }
}
```

```
}  
}
```

Here is the sample run of the above program:

```
asdfghjklly  
Print the content  
a s d f g h j k l y  
Converting characters to Upper case  
A  
S  
D  
F  
G  
H  
J  
K  
L  
Y
```

DataOutputStream

The `DataOutputStream` stream let you write the primitives to an output source.

Following is the constructor to create a `DataOutputStream`.

```
DataOutputStream out = new OutputStream(out);
```

Once you have `DataOutputStream` object in hand, then there is a list of helper methods, which can be used to write the stream or to do other operations on the stream.

SN	Methods with Description
1	public final void write(byte[] w, int off, int len) throws IOException Writes len bytes from the specified byte array starting at point off , to the underlying stream.
2	Public final int write(byte [] b) throws IOException Writes the current number of bytes written to this data output stream. Returns the total number of bytes write into the buffer.
3	(a) public final void writeBooolean() throws IOException, (b) public final void writeByte() throws IOException, (c) public final void writeShort() throws IOException (d) public final void writeInt() throws IOException These methods will write the specific primitive type data into the output stream as bytes.
4	Public void flush() throws IOException Flushes the data output stream.
5	public final void writeBytes(String s) throws IOException Writes out the string to the underlying output stream as a sequence of bytes. Each character in the string is written out, in sequence, by discarding its high eight bits.

Example:

Following is the example to demonstrate `DataInputStream` and `DataOutputStream`. This example reads 5 lines given in a file `test.txt` and converts those lines into capital letters and finally copies them into another file `test1.txt`.

```

import java.io.*;

public class Test{
    public static void main(String args[])throws IOException{

        DataInputStream d = new DataInputStream(new
            FileInputStream("test.txt"));

        DataOutputStream out = new DataOutputStream(new
            FileOutputStream("test1.txt"));

        String count;
        while((count = d.readLine()) != null){
            String u = count.toUpperCase();
            System.out.println(u);
            out.writeBytes(u + " ,");
        }
        d.close();
        out.close();
    }
}

```

Here is the sample run of the above program:

```

THIS IS TEST 1 ,
THIS IS TEST 2 ,
THIS IS TEST 3 ,
THIS IS TEST 4 ,
THIS IS TEST 5 ,

```

Example:

Following is the example to demonstrate InputStream and OutputStream:

```

import java.io.*;

public class FileStreamTest{

    public static void main(String args[]){

        try{
            byte bWrite [] = {11,21,3,40,5};
            OutputStream os = new FileOutputStream("test.txt");
            for(int x=0; x < bWrite.length ; x++){
                os.write( bWrite[x] ); // writes the bytes
            }
            os.close();

            InputStream is = new FileInputStream("test.txt");
            int size = is.available();

            for(int i=0; i< size; i++){
                System.out.print((char)is.read() + " ");
            }
            is.close();
        }catch(IOException e){
            System.out.print("Exception");
        }
    }
}

```

```
}
```

The above code would create file test.txt and would write given numbers in binary format. Same would be output on the stdout screen.

File Navigation and I/O:

There are several other classes that we would be going through to get to know the basics of File Navigation and I/O.

- [File Class](#)
- [FileReader Class](#)
- [FileWriter Class](#)

File Class

Java File class represents the files and directory pathnames in an abstract manner. This class is used for creation of files and directories, file searching, file deletion etc.

The File object represents the actual file/directory on the disk. There are following constructors to create a File object:

Following syntax creates a new File instance from a parent abstract pathname and a child pathname string.

```
File(File parent, String child);
```

Following syntax creates a new File instance by converting the given pathname string into an abstract pathname.

```
File(String pathname)
```

Following syntax creates a new File instance from a parent pathname string and a child pathname string.

```
File(String parent, String child)
```

Following syntax creates a new File instance by converting the given file: URI into an abstract pathname.

```
File(URI uri)
```

Once you have *File* object in hand then there is a list of helper methods which can be used to manipulate the files.

SN	Methods with Description
1	public String getName() Returns the name of the file or directory denoted by this abstract pathname.
2	public String getParent() Returns the pathname string of this abstract pathname's parent, or null if this pathname does not name a parent directory.
3	public File getParentFile() Returns the abstract pathname of this abstract pathname's parent, or null if this pathname does not name a parent directory.
4	public String getPath() Converts this abstract pathname into a pathname string.

5	public boolean isAbsolute() Tests whether this abstract pathname is absolute. Returns true if this abstract pathname is absolute, false otherwise
6	public String getAbsolutePath() Returns the absolute pathname string of this abstract pathname.
7	public boolean canRead() Tests whether the application can read the file denoted by this abstract pathname. Returns true if and only if the file specified by this abstract pathname exists and can be read by the application; false otherwise.
8	public boolean canWrite() Tests whether the application can modify to the file denoted by this abstract pathname. Returns true if and only if the file system actually contains a file denoted by this abstract pathname and the application is allowed to write to the file; false otherwise.
9	public boolean exists() Tests whether the file or directory denoted by this abstract pathname exists. Returns true if and only if the file or directory denoted by this abstract pathname exists; false otherwise
10	public boolean isDirectory() Tests whether the file denoted by this abstract pathname is a directory. Returns true if and only if the file denoted by this abstract pathname exists and is a directory; false otherwise.
11	public boolean isFile() Tests whether the file denoted by this abstract pathname is a normal file. A file is normal if it is not a directory and, in addition, satisfies other system-dependent criteria. Any non-directory file created by a Java application is guaranteed to be a normal file. Returns true if and only if the file denoted by this abstract pathname exists and is a normal file; false otherwise.
12	public long lastModified() Returns the time that the file denoted by this abstract pathname was last modified. Returns a long value representing the time the file was last modified, measured in milliseconds since the epoch (00:00:00 GMT, January 1, 1970), or 0L if the file does not exist or if an I/O error occurs.
13	public long length() Returns the length of the file denoted by this abstract pathname. The return value is unspecified if this pathname denotes a directory.
14	public boolean createNewFile() throws IOException Atomically creates a new, empty file named by this abstract pathname if and only if a file with this name does not yet exist. Returns true if the named file does not exist and was successfully created; false if the named file already exists.
15	public boolean delete() Deletes the file or directory denoted by this abstract pathname. If this pathname denotes a directory, then the directory must be empty in order to be deleted. Returns true if and only if the file or directory is successfully deleted; false otherwise.
16	public void deleteOnExit() Requests that the file or directory denoted by this abstract pathname be deleted when the virtual machine terminates.
17	public String[] list() Returns an array of strings naming the files and directories in the directory denoted by this abstract pathname.
18	public String[] list(FileNameFilter filter) Returns an array of strings naming the files and directories in the directory denoted by this abstract

	pathname that satisfy the specified filter.
20	public File[] listFiles() Returns an array of abstract pathnames denoting the files in the directory denoted by this abstract pathname.
21	public File[] listFiles(FileFilter filter) Returns an array of abstract pathnames denoting the files and directories in the directory denoted by this abstract pathname that satisfy the specified filter.
22	public boolean mkdir() Creates the directory named by this abstract pathname. Returns true if and only if the directory was created; false otherwise.
23	public boolean mkdirs() Creates the directory named by this abstract pathname, including any necessary but nonexistent parent directories. Returns true if and only if the directory was created, along with all necessary parent directories; false otherwise.
24	public boolean renameTo(File dest) Renames the file denoted by this abstract pathname. Returns true if and only if the renaming succeeded; false otherwise.
25	public boolean setLastModified(long time) Sets the last-modified time of the file or directory named by this abstract pathname. Returns true if and only if the operation succeeded; false otherwise.
26	public boolean setReadOnly() Marks the file or directory named by this abstract pathname so that only read operations are allowed. Returns true if and only if the operation succeeded; false otherwise.
27	public static File createTempFile(String prefix, String suffix, File directory) throws IOException Creates a new empty file in the specified directory, using the given prefix and suffix strings to generate its name. Returns an abstract pathname denoting a newly-created empty file.
28	public static File createTempFile(String prefix, String suffix) throws IOException Creates an empty file in the default temporary-file directory, using the given prefix and suffix to generate its name. Invoking this method is equivalent to invoking createTempFile(prefix, suffix, null). Returns abstract pathname denoting a newly-created empty file.
29	public int compareTo(File pathname) Compares two abstract pathnames lexicographically. Returns zero if the argument is equal to this abstract pathname, a value less than zero if this abstract pathname is lexicographically less than the argument, or a value greater than zero if this abstract pathname is lexicographically greater than the argument.
30	public int compareTo(Object o) Compares this abstract pathname to another object. Returns zero if the argument is equal to this abstract pathname, a value less than zero if this abstract pathname is lexicographically less than the argument, or a value greater than zero if this abstract pathname is lexicographically greater than the argument.
31	public boolean equals(Object obj) Tests this abstract pathname for equality with the given object. Returns true if and only if the argument is not null and is an abstract pathname that denotes the same file or directory as this abstract pathname.
32	public String toString() Returns the pathname string of this abstract pathname. This is just the string returned by the getPath() method.

Example:

Following is the example to demonstrate File object:

```
package com.tutorialspoint;

import java.io.File;

public class FileDemo {
    public static void main(String[] args) {

        File f = null;
        String[] strs = {"test1.txt", "test2.txt"};
        try{
            // for each string in string array
            for(String s:strs )
            {
                // create new file
                f= new File(s);

                // true if the file is executable
                boolean bool = f.canExecute();

                // find the absolute path
                String a = f.getAbsolutePath();

                // prints absolute path
                System.out.print(a);

                // prints
                System.out.println(" is executable: "+ bool);
            }
        }catch(Exception e){
            // if any I/O error occurs
            e.printStackTrace();
        }
    }
}
```

Consider there is an executable file test1.txt and another file test2.txt is non executable in current directory, Let us compile and run the above program, this will produce the following result:

```
test1.txt is executable: true
test2.txt is executable: false
```

FileReader Class

This class inherits from the InputStreamReader class. FileReader is used for reading streams of characters.

This class has several constructors to create required objects.

Following syntax creates a new FileReader, given the File to read from.

```
FileReader(File file)
```

Following syntax creates a new FileReader, given the FileDescriptor to read from.

```
FileReader(FileDescriptor fd)
```

Following syntax creates a new `FileReader`, given the name of the file to read from.

```
FileReader(String fileName)
```

Once you have `FileReader` object in hand then there is a list of helper methods which can be used manipulate the files.

SN	Methods with Description
1	public int read() throws IOException Reads a single character. Returns an int, which represents the character read.
2	public int read(char [] c, int offset, int len) Reads characters into an array. Returns the number of characters read.

Example:

Following is the example to demonstrate class:

```
import java.io.*;

public class FileRead{

    public static void main(String args[])throws IOException{

        File file = new File("Hello1.txt");
        // creates the file
        file.createNewFile();
        // creates a FileWriter Object
        FileWriter writer = new FileWriter(file);
        // Writes the content to the file
        writer.write("This\n is\n an\n example\n");
        writer.flush();
        writer.close();

        //Creates a FileReader Object
        FileReader fr = new FileReader(file);
        char [] a = new char[50];
        fr.read(a); // reads the content to the array
        for(char c : a)
            System.out.print(c); //prints the characters one by one
        fr.close();
    }
}
```

This would produce the following result:

```
This
is
an
example
```

FileWriter Class

This class inherits from the `OutputStreamWriter` class. The class is used for writing streams of characters.

TUTORIALS POINT

Simply Easy Learning

This class has several constructors to create required objects.

Following syntax creates a `FileWriter` object given a `File` object.

```
FileWriter(File file)
```

Following syntax creates a `FileWriter` object given a `File` object.

```
FileWriter(File file, boolean append)
```

Following syntax creates a `FileWriter` object associated with a file descriptor.

```
FileWriter(FileDescriptor fd)
```

Following syntax creates a `FileWriter` object given a file name.

```
FileWriter(String fileName)
```

Following syntax creates a `FileWriter` object given a file name with a boolean indicating whether or not to append the data written.

```
FileWriter(String fileName, boolean append)
```

Once you have `FileWriter` object in hand, then there is a list of helper methods, which can be used manipulate the files.

SN	Methods with Description
1	public void write(int c) throws IOException Writes a single character.
2	public void write(char [] c, int offset, int len) Writes a portion of an array of characters starting from offset and with a length of len.
3	public void write(String s, int offset, int len) Write a portion of a String starting from offset and with a length of len.

Example:

Following is the example to demonstrate class:

```
import java.io.*;

public class FileRead{

    public static void main(String args[])throws IOException{

        File file = new File("Hello1.txt");
        // creates the file
        file.createNewFile();
        // creates a FileWriter Object
        FileWriter writer = new FileWriter(file);
        // Writes the content to the file
        writer.write("This\n is\n an\n example\n");
        writer.flush();
        writer.close();

        //Creates a FileReader Object
        FileReader fr = new FileReader(file);
```

TUTORIALS POINT

Simply Easy Learning

```
char [] a = new char[50];
fr.read(a); // reads the content to the array
for(char c : a)
    System.out.print(c); //prints the characters one by one
fr.close();
}
}
```

This would produce the following result:

```
This
is
an
example
```

Directories in Java:

A directory is a File which can contains a list of other files and directories. You use **File** object to create directories, to list down files available in a directory. For complete detail check a list of all the methods which you can call on File object and what are related to directories.

Creating Directories:

There are two useful **File** utility methods, which can be used to create directories:

- The **mkdir()** method creates a directory, returning true on success and false on failure. Failure indicates that the path specified in the File object already exists, or that the directory cannot be created because the entire path does not exist yet.
- The **mkdirs()** method creates both a directory and all the parents of the directory.

Following example creates "/tmp/user/java/bin" directory:

```
import java.io.File;

public class CreateDir {
    public static void main(String args[]) {
        String dirname = "/tmp/user/java/bin";
        File d = new File(dirname);
        // Create directory now.
        d.mkdirs();
    }
}
```

Compile and execute above code to create "/tmp/user/java/bin".

Note: Java automatically takes care of path separators on UNIX and Windows as per conventions. If you use a forward slash (/) on a Windows version of Java, the path will still resolve correctly.

Listing Directories:

You can use **list()** method provided by **File** object to list down all the files and directories available in a directory as follows:

```
import java.io.File;

public class ReadDir {
    public static void main(String[] args) {
```

```
File file = null;
String[] paths;

try{
    // create new file object
    file = new File("/tmp");

    // array of files and directory
    paths = file.list();

    // for each name in the path array
    for(String path:paths)
    {
        // prints filename and directory name
        System.out.println(path);
    }
} catch(Exception e){
    // if any error occurs
    e.printStackTrace();
}
}
```

This would produce following result based on the directories and files available in your **/tmp** directory:

```
test1.txt
test2.txt
ReadDir.java
ReadDir.class
```

Java Exceptions

An exception is a problem that arises during the execution of a program. An exception can occur for many different reasons, including the following:

- A user has entered invalid data.
- A file that needs to be opened cannot be found.
- A network connection has been lost in the middle of communications or the JVM has run out of memory.

Some of these exceptions are caused by user error, others by programmer error, and others by physical resources that have failed in some manner.

To understand how exception handling works in Java, you need to understand the three categories of exceptions:

- **Checked exceptions:** A checked exception is an exception that is typically a user error or a problem that cannot be foreseen by the programmer. For example, if a file is to be opened, but the file cannot be found, an exception occurs. These exceptions cannot simply be ignored at the time of compilation.
- **Runtime exceptions:** A runtime exception is an exception that occurs that probably could have been avoided by the programmer. As opposed to checked exceptions, runtime exceptions are ignored at the time of compilation.
- **Errors:** These are not exceptions at all, but problems that arise beyond the control of the user or the programmer. Errors are typically ignored in your code because you can rarely do anything about an error. For example, if a stack overflow occurs, an error will arise. They are also ignored at the time of compilation.

Exception Hierarchy:

All exception classes are subtypes of the `java.lang.Exception` class. The exception class is a subclass of the `Throwable` class. Other than the exception class there is another subclass called `Error` which is derived from the `Throwable` class.

Errors are not normally trapped from the Java programs. These conditions normally happen in case of severe failures, which are not handled by the java programs. Errors are generated to indicate errors generated by the runtime environment. Example : JVM is out of Memory. Normally programs cannot recover from errors.

The Exception class has two main subclasses: `IOException` class and `RuntimeException` Class.

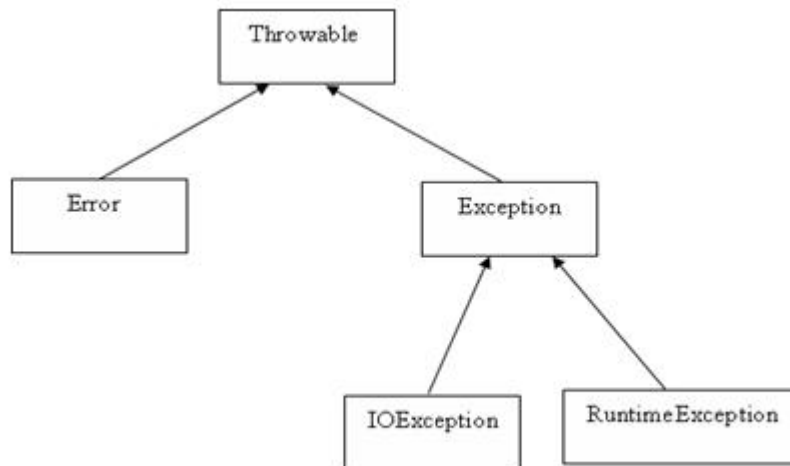

Here is a list of most common checked and unchecked **Java's Built-in Exceptions**.

Java's Built-in Exceptions

Java defines several exception classes inside the standard package **java.lang**.

The most general of these exceptions are subclasses of the standard type RuntimeException. Since java.lang is implicitly imported into all Java programs, most exceptions derived from RuntimeException are automatically available.

Java defines several other types of exceptions that relate to its various class libraries. Following is the list of Java Unchecked RuntimeException.

Exception	Description
ArithmeticException	Arithmetic error, such as divide-by-zero.
ArrayIndexOutOfBoundsException	Array index is out-of-bounds.
ArrayStoreException	Assignment to an array element of an incompatible type.
ClassCastException	Invalid cast.
IllegalArgumentException	Illegal argument used to invoke a method.
IllegalMonitorStateException	Illegal monitor operation, such as waiting on an unlocked thread.
IllegalStateException	Environment or application is in incorrect state.
IllegalThreadStateException	Requested operation not compatible with current thread state.
IndexOutOfBoundsException	Some type of index is out-of-bounds.
NegativeArraySizeException	Array created with a negative size.
NullPointerException	Invalid use of a null reference.
NumberFormatException	Invalid conversion of a string to a numeric format.
SecurityException	Attempt to violate security.
StringIndexOutOfBoundsException	Attempt to index outside the bounds of a string.

UnsupportedOperationException	An unsupported operation was encountered.
-------------------------------	---

Following is the list of Java Checked Exceptions Defined in java.lang.

Exception	Description
ClassNotFoundException	Class not found.
CloneNotSupportedException	Attempt to clone an object that does not implement the Cloneable interface.
IllegalAccessException	Access to a class is denied.
InstantiationException	Attempt to create an object of an abstract class or interface.
InterruptedException	One thread has been interrupted by another thread.
NoSuchFieldException	A requested field does not exist.
NoSuchMethodException	A requested method does not exist.

Exceptions Methods:

Following is the list of important methods available in the Throwable class.

SN	Methods with Description
1	public String getMessage() Returns a detailed message about the exception that has occurred. This message is initialized in the Throwable constructor.
2	public Throwable getCause() Returns the cause of the exception as represented by a Throwable object.
3	public String toString() Returns the name of the class concatenated with the result of getMessage()
4	public void printStackTrace() Prints the result of toString() along with the stack trace to System.err, the error output stream.
5	public StackTraceElement [] getStackTrace() Returns an array containing each element on the stack trace. The element at index 0 represents the top of the call stack, and the last element in the array represents the method at the bottom of the call stack.
6	public Throwable fillInStackTrace() Fills the stack trace of this Throwable object with the current stack trace, adding to any previous information in the stack trace.

Catching Exceptions:

A method catches an exception using a combination of the **try** and **catch** keywords. A try/catch block is placed around the code that might generate an exception. Code within a try/catch block is referred to as protected code, and the syntax for using try/catch looks like the following:

```
try
{
//Protected code
}catch(ExceptionName e1)
{
```



```
//Catch block  
}
```

A catch statement involves declaring the type of exception you are trying to catch. If an exception occurs in protected code, the catch block (or blocks) that follows the try is checked. If the type of exception that occurred is listed in a catch block, the exception is passed to the catch block much as an argument is passed into a method parameter.

Example:

The following is an array is declared with 2 elements. Then, the code tries to access the 3rd element of the array which throws an exception.

```
// File Name : ExcepTest.java  
import java.io.*;  
public class ExcepTest{  
  
    public static void main(String args[]){  
        try{  
            int a[]=new int[2];  
            System.out.println("Access element three :"+ a[3]);  
        }catch(ArrayIndexOutOfBoundsException e){  
            System.out.println("Exception thrown :"+ e);  
        }  
        System.out.println("Out of the block");  
    }  
}
```

This would produce the following result:

```
Exception thrown :java.lang.ArrayIndexOutOfBoundsException:3  
Out of the block
```

Multiple catch Blocks:

A try block can be followed by multiple catch blocks. The syntax for multiple catch blocks looks like the following:

```
try  
{  
    //Protected code  
}catch(ExceptionType1 e1)  
{  
    //Catch block  
}catch(ExceptionType2 e2)  
{  
    //Catch block  
}catch(ExceptionType3 e3)  
{  
    //Catch block  
}
```

The previous statements demonstrate three catch blocks, but you can have any number of them after a single try. If an exception occurs in the protected code, the exception is thrown to the first catch block in the list. If the data type of the exception thrown matches ExceptionType1, it gets caught there. If not, the exception passes down to the second catch statement. This continues until the exception either is caught or falls through all catches, in which case the current method stops execution and the exception is thrown down to the previous method on the call stack.

Example:

Here is code segment showing how to use multiple try/catch statements.

```
try
{
    file =newFileInputStream(fileName);
    x =(byte) file.read();
}catch(IOException i)
{
    i.printStackTrace();
return-1;
}catch(FileNotFoundException f)//Not valid!
{
    f.printStackTrace();
return-1;
}
```

The throws/throw Keywords:

If a method does not handle a checked exception, the method must declare it using the **throws** keyword. The throws keyword appears at the end of a method's signature.

You can throw an exception, either a newly instantiated one or an exception that you just caught, by using the **throw** keyword. Try to understand the different in throws and throw keywords.

The following method declares that it throws a RemoteException:

```
import java.io.*;
public class className
{
    public void deposit(double amount)throws RemoteException
    {
        // Method implementation
        throw new RemoteException();
    }
    //Remainder of class definition
}
```

A method can declare that it throws more than one exception, in which case the exceptions are declared in a list separated by commas. For example, the following method declares that it throws a RemoteException and an InsufficientFundsException:

```
import java.io.*;
public class className
{
    public void withdraw(double amount)throws RemoteException,
    InsufficientFundsException
    {
        // Method implementation
    }
    //Remainder of class definition
}
```

The finally Keyword

The finally keyword is used to create a block of code that follows a try block. A finally block of code always executes, whether or not an exception has occurred.

Using a finally block allows you to run any cleanup-type statements that you want to execute, no matter what happens in the protected code.

A finally block appears at the end of the catch blocks and has the following syntax:

```
try
{
//Protected code
}catch(ExceptionType1 e1)
{
//Catch block
}catch(ExceptionType2 e2)
{
//Catch block
}catch(ExceptionType3 e3)
{
//Catch block
}finally
{
//The finally block always executes.
}
```

Example:

```
public class ExceptTest{

public static void main(String args[]){
int a[]=new int[2];
try{
System.out.println("Access element three :"+ a[3]);
}catch(ArrayIndexOutOfBoundsException e){
System.out.println("Exception thrown :"+ e);
}
finally{
a[0]=6;
System.out.println("First element value: "+a[0]);
System.out.println("The finally statement is executed");
}
}
}
```

This would produce the following result:

```
Exception thrown :java.lang.ArrayIndexOutOfBoundsException:3
First element value:6
The finally statement is executed
```

Note the following:

- A catch clause cannot exist without a try statement.
- It is not compulsory to have finally clauses whenever a try/catch block is present.
- The try block cannot be present without either catch clause or finally clause.
- Any code cannot be present in between the try, catch, finally blocks.

Declaring you own Exception:

You can create your own exceptions in Java. Keep the following points in mind when writing your own exception classes:

- All exceptions must be a child of Throwable.
- If you want to write a checked exception that is automatically enforced by the Handle or Declare Rule, you need to extend the Exception class.
- If you want to write a runtime exception, you need to extend the RuntimeException class.

We can define our own Exception class as below:

```
class MyException extends Exception{  
}
```

You just need to extend the Exception class to create your own Exception class. These are considered to be checked exceptions. The following InsufficientFundsException class is a user-defined exception that extends the Exception class, making it a checked exception. An exception class is like any other class, containing useful fields and methods.

Example:

```
// File Name InsufficientFundsException.java  
import java.io.*;  
  
public class InsufficientFundsException extends Exception  
{  
    private double amount;  
    public InsufficientFundsException(double amount)  
    {  
        this.amount = amount;  
    }  
    public double getAmount()  
    {  
        return amount;  
    }  
}
```

To demonstrate using our user-defined exception, the following CheckingAccount class contains a withdraw() method that throws an InsufficientFundsException.

```
// File Name CheckingAccount.java  
import java.io.*;  
  
public class CheckingAccount  
{  
    private double balance;  
    private int number;  
    public CheckingAccount(int number)  
    {  
        this.number = number;  
    }  
    public void deposit(double amount)  
    {  
        balance += amount;  
    }  
}
```

TUTORIALS POINT

Simply Easy Learning

```

public void withdraw(double amount) throws InsufficientFundsException
{
    if (amount <= balance)
    {
        balance -= amount;
    }
    else
    {
        double needs = amount - balance;
        throw new InsufficientFundsException(needs);
    }
}
public double getBalance()
{
    return balance;
}
public int getNumber()
{
    return number;
}
}

```

The following BankDemo program demonstrates invoking the deposit() and withdraw() methods of CheckingAccount.

```

// File Name BankDemo.java
public class BankDemo
{
    public static void main(String[] args)
    {
        CheckingAccount c = new CheckingAccount(101);
        System.out.println("Depositing $500...");
        c.deposit(500.00);
        try
        {
            System.out.println("\nWithdrawing $100...");
            c.withdraw(100.00);
            System.out.println("\nWithdrawing $600...");
            c.withdraw(600.00);
        } catch (InsufficientFundsException e)
        {
            System.out.println("Sorry, but you are short $"
+ e.getAmount());
            e.printStackTrace();
        }
    }
}

```

Compile all the above three files and run BankDemo, this would produce the following result:

```

Depositing $500...

Withdrawing $100...

Withdrawing $600...
Sorry, but you are short $200.0
InsufficientFundsException
    at CheckingAccount.withdraw(CheckingAccount.java:25)
    at BankDemo.main(BankDemo.java:13)

```

Common Exceptions:

In Java, it is possible to define two categories of Exceptions and Errors.

- **JVM Exceptions:** - These are exceptions/errors that are exclusively or logically thrown by the JVM. Examples : NullPointerException, ArrayIndexOutOfBoundsException, ClassCastException,
- **Programmatic exceptions:-** These exceptions are thrown explicitly by the application or the API programmers. Examples: IllegalArgumentException, IllegalStateException.

Java Inheritance

Inheritance can be defined as the process where one object acquires the properties of another. With the use of inheritance, the information is made manageable in a hierarchical order.

When we talk about inheritance, the most commonly used keyword would be **extends** and **implements**. These words would determine whether one object IS-A type of another. By using these keywords we can make one object acquire the properties of another object.

IS-A Relationship:

IS-A is a way of saying : This object is a type of that object. Let us see how the **extends** keyword is used to achieve inheritance.

```
public class Animal{
}

public class Mammal extends Animal{
}

public class Reptile extends Animal{
}

public class Dog extends Mammal{
}
```

Now, based on the above example, In Object Oriented terms the following are true:

- Animal is the superclass of Mammal class.
- Animal is the superclass of Reptile class.
- Mammal and Reptile are subclasses of Animal class.
- Dog is the subclass of both Mammal and Animal classes.

Now, if we consider the IS-A relationship, we can say:

- Mammal IS-A Animal
- Reptile IS-A Animal

- Dog IS-A Mammal
- Hence : Dog IS-A Animal as well

With use of the extends keyword the subclasses will be able to inherit all the properties of the superclass except for the private properties of the superclass.

We can assure that Mammal is actually an Animal with the use of the instance operator.

Example:

```
public class Dog extends Mammal{

public static void main(String args[]){

Animal a =new Animal();
Mammal m =new Mammal();
Dog d =new Dog();

System.out.println(m instanceof Animal);
System.out.println(d instanceof Mammal);
System.out.println(d instanceof Animal);
}
}
```

This would produce the following result:

```
true
true
true
```

Since we have a good understanding of the **extends** keyword, let us look into how the **implements** keyword is used to get the IS-A relationship.

The **implements** keyword is used by classes by inherit from interfaces. Interfaces can never be extended by the classes.

Example:

```
public interface Animal{}

public class Mammal implements Animal{
}

public class Dog extends Mammal{
}
```

The instanceof Keyword:

Let us use the **instanceof** operator to check determine whether Mammal is actually an Animal, and dog is actually an Animal

```
interfaceAnimal{}

class Mammal implements Animal{}

public class Dog extends Mammal{
public static void main(String args[]){
```



```
Mammal m =new Mammal();
Dog d =new Dog();

System.out.println(m instanceof Animal);
System.out.println(d instanceof Mammal);
System.out.println(d instanceof Animal);
}
}
```

This would produce the following result:

```
true
true
true
```

HAS-A relationship:

These relationships are mainly based on the usage. This determines whether a certain class **HAS-A** certain thing. This relationship helps to reduce duplication of code as well as bugs.

Lets us look into an example:

```
public class Vehicle{}
public class Speed{}
public class Van extends Vehicle{
private Speed sp;
}
```

This shows that class Van HAS-A Speed. By having a separate class for Speed, we do not have to put the entire code that belongs to speed inside the Van class which makes it possible to reuse the Speed class in multiple applications.

In Object-Oriented feature, the users do not need to bother about which object is doing the real work. To achieve this, the Van class hides the implementation details from the users of the Van class. So basically what happens is the users would ask the Van class to do a certain action and the Van class will either do the work by itself or ask another class to perform the action.

A very important fact to remember is that Java only supports only single inheritance. This means that a class cannot extend more than one class. Therefore following is illegal:

```
public class extendsAnimal,Mammal{ }
```

However, a class can implement one or more interfaces. This has made Java get rid of the impossibility of multiple inheritance.

Java Overriding

In the previous chapter, we talked about superclasses and subclasses. If a class inherits a method from its superclass, then there is a chance to override the method provided that it is not marked final.

The benefit of overriding is: ability to define a behavior that's specific to the subclass type which means a subclass can implement a parent class method based on its requirement.

In object-oriented terms, overriding means to override the functionality of an existing method.

Example:

Let us look at an example.

```
class Animal{  
  
    public void move(){  
        System.out.println("Animals can move");  
    }  
}  
  
class Dog extends Animal{  
  
    public void move(){  
        System.out.println("Dogs can walk and run");  
    }  
}  
  
public class TestDog{  
  
    public static void main(String args[]){  
        Animal a =new Animal();// Animal reference and object  
        Animal b =new Dog();// Animal reference but Dog object  
  
        a.move();// runs the method in Animal class  
  
        b.move();//Runs the method in Dog class  
    }  
}
```

This would produce the following result:

```
Animals can move
Dogs can walk and run
```

In the above example, you can see that even though **b** is a type of `Animal` it runs the `move` method in the `Dog` class. The reason for this is: In compile time, the check is made on the reference type. However, in the runtime, JVM figures out the object type and would run the method that belongs to that particular object.

Therefore, in the above example, the program will compile properly since `Animal` class has the method `move`. Then, at the runtime, it runs the method specific for that object.

Consider the following example:

```
class Animal{

public void move(){
System.out.println("Animals can move");
}
}

class Dog extends Animal{

public void move(){
System.out.println("Dogs can walk and run");
}
public void bark(){
System.out.println("Dogs can bark");
}
}

public class TestDog{

public static void main(String args[]){
Animal a =new Animal();// Animal reference and object
Animal b =new Dog();// Animal reference but Dog object

    a.move();// runs the method in Animal class
    b.move();//Runs the method in Dog class
    b.bark();
}
}
```

This would produce the following result:

```
TestDog.java:30: cannot find symbol
symbol   : method bark()
location: class Animal
           b.bark();
^
```

This program will throw a compile time error since `b`'s reference type `Animal` doesn't have a method by the name of `bark`.

Rules for method overriding:

- The argument list should be exactly the same as that of the overridden method.
- The return type should be the same or a subtype of the return type declared in the original overridden method in the superclass.

- The access level cannot be more restrictive than the overridden method's access level. For example, if the superclass method is declared public, then the overriding method in the subclass cannot be either private or protected.
- Instance methods can be overridden only if they are inherited by the subclass.
- A method declared final cannot be overridden.
- A method declared static cannot be overridden but can be re-declared.
- If a method cannot be inherited, then it cannot be overridden.
- A subclass within the same package as the instance's superclass can override any superclass method that is not declared private or final.
- A subclass in a different package can only override the non-final methods declared public or protected.
- An overriding method can throw any unchecked exceptions, regardless of whether the overridden method throws exceptions or not. However the overriding method should not throw checked exceptions that are new or broader than the ones declared by the overridden method. The overriding method can throw narrower or fewer exceptions than the overridden method.
- Constructors cannot be overridden.

Using the super keyword:

When invoking a superclass version of an overridden method the **super** keyword is used.

```
class Animal{
    public void move(){
        System.out.println("Animals can move");
    }
}

class Dog extends Animal{
    public void move(){
        super.move();// invokes the super class method
        System.out.println("Dogs can walk and run");
    }
}

public class TestDog{
    public static void main(String args[]){
        Animal b =new Dog();// Animal reference but Dog object
        b.move();//Runs the method in Dog class
    }
}
```

This would produce the following result:

```
Animals can move
Dogs can walk and run
```

Java Polymorphism

Polymorphism is the ability of an object to take on many forms. The most common use of polymorphism in OOP, occurs when a parent class reference is used to refer to a child class object.

Any Java object that can pass more than one IS-A test is considered to be polymorphic. In Java, all Java objects are polymorphic since any object will pass the IS-A test for their own type and for the class Object.

It is important to know that the only possible way to access an object is through a reference variable. A reference variable can be of only one type. Once declared, the type of a reference variable cannot be changed.

The reference variable can be reassigned to other objects provided that it is not declared final. The type of the reference variable would determine the methods that it can invoke on the object.

A reference variable can refer to any object of its declared type or any subtype of its declared type. A reference variable can be declared as a class or interface type.

Example:

Let us look at an example.

```
public interface Vegetarian {}
public class Animal {}
public class Deer extends Animal implements Vegetarian {}
```

Now, the Deer class is considered to be polymorphic since this has multiple inheritance. Following are true for the above example:

- A Deer IS-A Animal
- A Deer IS-A Vegetarian
- A Deer IS-A Deer
- A Deer IS-A Object

When we apply the reference variable facts to a Deer object reference, the following declarations are legal:

```
Deer d = new Deer();
Animal a = d;
```

```
Vegetarian v = d;  
Object o = d;
```

All the reference variables d,a,v,o refer to the same Deer object in the heap.

Virtual Methods:

In this section, I will show you how the behavior of overridden methods in Java allows you to take advantage of polymorphism when designing your classes.

We already have discussed method overriding, where a child class can override a method in its parent. An overridden method is essentially hidden in the parent class, and is not invoked unless the child class uses the super keyword within the overriding method.

```
/* File name : Employee.java */  
public class Employee  
{  
    private String name;  
    private String address;  
    private int number;  
    public Employee(String name,String address,int number)  
    {  
        System.out.println("Constructing an Employee");  
        this.name = name;  
        this.address = address;  
        this.number = number;  
    }  
    public void mailCheck()  
    {  
        System.out.println("Mailing a check to "+this.name  
        +" "+this.address);  
    }  
    public String toString()  
    {  
        return name +" "+ address +" "+ number;  
    }  
    public String getName()  
    {  
        return name;  
    }  
    public String getAddress()  
    {  
        return address;  
    }  
    public void setAddress(String newAddress)  
    {  
        address = newAddress;  
    }  
    public int getNumber()  
    {  
        return number;  
    }  
}
```

Now suppose we extend Employee class as follows:

```
/* File name : Salary.java */  
public class Salaryextends Employee  
{  
    private double salary;//Annual salary
```

TUTORIALS POINT

Simply Easy Learning

```

public Salary(String name,String address,int number,double
    salary)
{
    super(name, address, number);
    setSalary(salary);
}
public void mailCheck()
{
    System.out.println("Within mailCheck of Salary class ");
    System.out.println("Mailing check to "+ getName()
+" with salary "+ salary);
}
public double getSalary()
{
    return salary;
}
public void setSalary(double newSalary)
{
    if(newSalary >=0.0)
    {
        salary = newSalary;
    }
}
public double computePay()
{
    System.out.println("Computing salary pay for "+ getName());
    return salary/52;
}
}

```

Now, you study the following program carefully and try to determine its output:

```

/* File name : VirtualDemo.java */
public class VirtualDemo
{
    public static void main(String[] args)
    {
        Salary s =new Salary("Mohd Mohtashim","Ambehta, UP",
3,3600.00);
        Employee e =new Salary("John Adams","Boston, MA",
2,2400.00);
        System.out.println("Call mailCheck using Salary reference --");
        s.mailCheck();
        System.out.println("\n Call mailCheck usingEmployee reference--");
        e.mailCheck();
    }
}

```

This would produce the following result:

```

Constructing an Employee
Constructing an Employee
Call mailCheck using Salary reference --
Within mailCheck of Salary class
Mailing check to MohdMohtashim with salary 3600.0

Call mailCheck using Employee reference--
Within mailCheck of Salary class
Mailing check to JohnAdams with salary 2400.0

```

TUTORIALS POINT

Simply Easy Learning

Here, we instantiate two Salary objects, one using a Salary reference *s*, and the other using an Employee reference *e*.

While invoking *s.mailCheck()* the compiler sees *mailCheck()* in the Salary class at compile time, and the JVM invokes *mailCheck()* in the Salary class at run time.

Invoking *mailCheck()* on *e* is quite different because *e* is an Employee reference. When the compiler sees *e.mailCheck()*, the compiler sees the *mailCheck()* method in the Employee class.

Here, at compile time, the compiler used *mailCheck()* in Employee to validate this statement. At run time, however, the JVM invokes *mailCheck()* in the Salary class.

This behavior is referred to as virtual method invocation, and the methods are referred to as virtual methods. All methods in Java behave in this manner, whereby an overridden method is invoked at run time, no matter what data type the reference is that was used in the source code at compile time.

Java Abstraction

Abstraction refers to the ability to make a class abstract in OOP. An abstract class is one that cannot be instantiated. All other functionality of the class still exists, and its fields, methods, and constructors are all accessed in the same manner. You just cannot create an instance of the abstract class.

If a class is abstract and cannot be instantiated, the class does not have much use unless it is subclass. This is typically how abstract classes come about during the design phase. A parent class contains the common functionality of a collection of child classes, but the parent class itself is too abstract to be used on its own.

Abstract Class:

Use the **abstract** keyword to declare a class abstract. The keyword appears in the class declaration somewhere before the class keyword.

```
/* File name : Employee.java */
public abstract class Employee
{
    private String name;
    private String address;
    private int number;
    public Employee(String name, String address, int number)
    {
        System.out.println("Constructing an Employee");
        this.name = name;
        this.address = address;
        this.number = number;
    }
    public double computePay()
    {
        System.out.println("Inside Employee computePay");
        return 0.0;
    }
    public void mailCheck()
    {
        System.out.println("Mailing a check to "+this.name
        +" "+this.address);
    }
    public String toString()
    {
        return name +" "+ address +" "+ number;
    }
}
```

TUTORIALS POINT

Simply Easy Learning

```

public String getName()
{
return name;
}
public String getAddress()
{
return address;
}
public void setAddress(String newAddress)
{
address = newAddress;
}
public int getNumber()
{
return number;
}
}

```

Notice that nothing is different in this Employee class. The class is now abstract, but it still has three fields, seven methods, and one constructor.

Now if you would try as follows:

```

/* File name : AbstractDemo.java */
public class AbstractDemo
{
public static void main(String[] args)
{
/* Following is not allowed and would raise error */
Employee e =new Employee("George W.,"Houston, TX",43);

System.out.println("\n Call mailCheck usingEmployee reference--");
e.mailCheck();
}
}

```

When you would compile above class, then you would get the following error:

```

Employee.java:46:Employee is abstract; cannot be instantiated
Employee e =new Employee("George W.,"Houston, TX",43);
^
1 error

```

Extending Abstract Class:

We can extend Employee class in normal way as follows:

```

/* File name : Salary.java */
public class Salary extends Employee
{
private double salary;//Annual salary
public Salary(String name,String address,int number,double salary)
{
super(name, address, number);
setSalary(salary);
}
public void mailCheck()
{
System.out.println("Within mailCheck of Salary class ");
System.out.println("Mailing check to "+ getName()

```

TUTORIALS POINT

Simply Easy Learning

```

+" with salary "+ salary);
}
public double getSalary()
{
return salary;
}
public void setSalary(double newSalary)
{
if(newSalary >=0.0)
{
salary = newSalary;
}
}
public double computePay()
{
System.out.println("Computing salary pay for "+ getName());
return salary/52;
}
}

```

Here, we cannot instantiate a new Employee, but if we instantiate a new Salary object, the Salary object will inherit the three fields and seven methods from Employee.

```

/* File name : AbstractDemo.java */
public class AbstractDemo
{
public static void main(String[] args)
{
Salary s =new Salary("Mohd Mohtashim","Ambehta, UP",
3,3600.00);
Employee e =new Salary("John Adams","Boston, MA",
2,2400.00);

System.out.println("Call mailCheck using Salary reference --");
s.mailCheck();
System.out.println("\n Call mailCheck usingEmployee reference--");
e.mailCheck();
}
}

```

This would produce the following result:

```

Constructing an Employee
Constructing an Employee
Call mailCheck using Salary reference --
Within mailCheck of Salary class
Mailing check to MohdMohtashim with salary 3600.0

Call mailCheck using Employee reference--
Within mailCheck of Salary class
Mailing check to JohnAdams with salary 2400.

```

Abstract Methods:

If you want a class to contain a particular method but you want the actual implementation of that method to be determined by child classes, you can declare the method in the parent class as abstract.

The abstract keyword is also used to declare a method as abstract. An abstract method consists of a method signature, but no method body.

TUTORIALS POINT

Simply Easy Learning

Abstract method would have no definition, and its signature is followed by a semicolon, not curly braces as follows:

```
public abstract class Employee
{
private String name;
private String address;
private int number;

public abstract double computePay();

//Remainder of class definition
}
```

Declaring a method as abstract has two results:

- The class must also be declared abstract. If a class contains an abstract method, the class must be abstract as well.
- Any child class must either override the abstract method or declare itself abstract.

A child class that inherits an abstract method must override it. If they do not, they must be abstract and any of their children must override it.

Eventually, a descendant class has to implement the abstract method; otherwise, you would have a hierarchy of abstract classes that cannot be instantiated.

If Salary is extending Employee class, then it is required to implement computePay() method as follows:

```
/* File name : Salary.java */
public class Salary extends Employee
{
private double salary; // Annual salary

public double computePay()
{
System.out.println("Computing salary pay for "+ getName());
return salary/52;
}

//Remainder of class definition
}
```

Java Encapsulation

Encapsulation is one of the four fundamental OOP concepts. The other three are inheritance, polymorphism, and abstraction.

Encapsulation is the technique of making the fields in a class private and providing access to the fields via public methods. If a field is declared private, it cannot be accessed by anyone outside the class, thereby hiding the fields within the class. For this reason, encapsulation is also referred to as data hiding.

Encapsulation can be described as a protective barrier that prevents the code and data being randomly accessed by other code defined outside the class. Access to the data and code is tightly controlled by an interface.

The main benefit of encapsulation is the ability to modify our implemented code without breaking the code of others who use our code. With this feature Encapsulation gives maintainability, flexibility and extensibility to our code.

Example:

Let us look at an example that depicts encapsulation:

```
/* File name : EncapTest.java */
public class EncapTest{

    private String name;
    private String idNum;
    private int age;

    public int getAge(){
        return age;
    }

    publicString getName(){
        return name;
    }

    publicString getIdNum(){
        return idNum;
    }

    publicvoid setAge(int newAge){
        age = newAge;
    }

    publicvoid setName(String newName){
```

TUTORIALS POINT

Simply Easy Learning

```
name = newName;
}

public void setIdNum(String newId) {
    idNum = newId;
}
}
```

The public methods are the access points to this class' fields from the outside java world. Normally, these methods are referred as getters and setters. Therefore any class that wants to access the variables should access them through these getters and setters.

The variables of the EncapTest class can be access as below:

```
/* File name : RunEncap.java */
public class RunEncap{

    public static void main(String args[]){
        EncapTest encap =new EncapTest();
        encap.setName("James");
        encap.setAge(20);
        encap.setIdNum("12343ms");

        System.out.print("Name : "+ encap.getName()+" Age : "+ encap.getAge());
    }
}
```

This would produce the following result:

```
Name:JamesAge:20
```

Benefits of Encapsulation:

The fields of a class can be made read-only or write-only.

A class can have total control over what is stored in its fields.

The users of a class do not know how the class stores its data. A class can change the data type of a field and users of the class do not need to change any of their code.

Java Interfaces

An interface is a collection of abstract methods. A class implements an interface, thereby inheriting the abstract methods of the interface.

An interface is not a class. Writing an interface is similar to writing a class, but they are two different concepts. A class describes the attributes and behaviors of an object. An interface contains behaviors that a class implements.

Unless the class that implements the interface is abstract, all the methods of the interface need to be defined in the class.

An interface is similar to a class in the following ways:

- An interface can contain any number of methods.
- An interface is written in a file with a **.java** extension, with the name of the interface matching the name of the file.
- The bytecode of an interface appears in a **.class** file.
- Interfaces appear in packages, and their corresponding bytecode file must be in a directory structure that matches the package name.

However, an interface is different from a class in several ways, including:

- You cannot instantiate an interface.
- An interface does not contain any constructors.
- All of the methods in an interface are abstract.
- An interface cannot contain instance fields. The only fields that can appear in an interface must be declared both static and final.
- An interface is not extended by a class; it is implemented by a class.
- An interface can extend multiple interfaces.

Declaring Interfaces:

The **interface** keyword is used to declare an interface. Here is a simple example to declare an interface:

Example:

Let us look at an example that depicts encapsulation:

```
/* File name : NameOfInterface.java */
import java.lang.*;
//Any number of import statements

public interface NameOfInterface
{
//Any number of final, static fields
//Any number of abstract method declarations\
}
```

Interfaces have the following properties:

- An interface is implicitly abstract. You do not need to use the **abstract** keyword when declaring an interface.
- Each method in an interface is also implicitly abstract, so the abstract keyword is not needed.
- Methods in an interface are implicitly public.

Example:

```
/* File name : Animal.java */
interface Animal{

public void eat();
public void travel();
}
```

Implementing Interfaces:

When a class implements an interface, you can think of the class as signing a contract, agreeing to perform the specific behaviors of the interface. If a class does not perform all the behaviors of the interface, the class must declare itself as abstract.

A class uses the **implements** keyword to implement an interface. The implements keyword appears in the class declaration following the extends portion of the declaration.

```
/* File name : MammalInt.java */
public class MammalInt implements Animal{

public void eat(){
System.out.println("Mammal eats");
}

public void travel(){
System.out.println("Mammal travels");
}

public int noOfLegs(){
return 0;
}
```

TUTORIALS POINT

Simply Easy Learning

```
public static void main(String args[]){
MammalInt m =new MammalInt();
    m.eat();
    m.travel();
}
}
```

This would produce the following result:

```
Mammal eats
Mammal travels
```

When overriding methods defined in interfaces there are several rules to be followed:

- Checked exceptions should not be declared on implementation methods other than the ones declared by the interface method or subclasses of those declared by the interface method.
- The signature of the interface method and the same return type or subtype should be maintained when overriding the methods.
- An implementation class itself can be abstract and if so interface methods need not be implemented.

When implementing interfaces there are several rules:

- A class can implement more than one interface at a time.
- A class can extend only one class, but implement many interfaces.
- An interface can extend another interface, similarly to the way that a class can extend another class.

Extending Interfaces:

An interface can extend another interface, similarly to the way that a class can extend another class. The **extends** keyword is used to extend an interface, and the child interface inherits the methods of the parent interface.

The following Sports interface is extended by Hockey and Football interfaces.

```
//Filename: Sports.java
public interface Sports
{
public void setHomeTeam(String name);
public void setVisitingTeam(String name);
}

//Filename: Football.java
public interface Football extends Sports
{
public void homeTeamScored(int points);
public void visitingTeamScored(int points);
public void endOfQuarter(int quarter);
}

//Filename: Hockey.java
public interface Hockey extends Sports
{
public void homeGoalScored();
}
```

```
public void visitingGoalScored();
public void endOfPeriod(int period);
public void overtimePeriod(int ot);
}
```

The Hockey interface has four methods, but it inherits two from Sports; thus, a class that implements Hockey needs to implement all six methods. Similarly, a class that implements Football needs to define the three methods from Football and the two methods from Sports.

Extending Multiple Interfaces:

A Java class can only extend one parent class. Multiple inheritance is not allowed. Interfaces are not classes, however, and an interface can extend more than one parent interface.

The extends keyword is used once, and the parent interfaces are declared in a comma-separated list.

For example, if the Hockey interface extended both Sports and Event, it would be declared as:

```
public interface Hockey extends Sports, Event
```

Tagging Interfaces:

The most common use of extending interfaces occurs when the parent interface does not contain any methods. For example, the `MouseListener` interface in the `java.awt.event` package extended `java.util.EventListener`, which is defined as:

```
package java.util;
public interface EventListener
{ }
```

An interface with no methods in it is referred to as a **tagging** interface. There are two basic design purposes of tagging interfaces:

Creates a common parent: As with the `EventListener` interface, which is extended by dozens of other interfaces in the Java API, you can use a tagging interface to create a common parent among a group of interfaces. For example, when an interface extends `EventListener`, the JVM knows that this particular interface is going to be used in an event delegation scenario.

Adds a data type to a class: This situation is where the term tagging comes from. A class that implements a tagging interface does not need to define any methods (since the interface does not have any), but the class becomes an interface type through polymorphism.

Java Packages

Packages are used in Java in order to prevent naming conflicts, to control access, to make searching/locating and usage of classes, interfaces, enumerations and annotations easier, etc.

A Package can be defined as a grouping of related types (classes, interfaces, enumerations and annotations) providing access protection and name space management.

Some of the existing packages in Java are:

- **java.lang** - bundles the fundamental classes
- **java.io** - classes for input, output functions are bundled in this package

Programmers can define their own packages to bundle a group of classes/interfaces, etc. It is a good practice to group related classes implemented by you so that a programmer can easily determine that the classes, interfaces, enumerations, annotations are related.

Since the package creates a new namespace there won't be any name conflicts with names in other packages. Using packages, it is easier to provide access control and it is also easier to locate the related classes.

Creating a package:

When creating a package, you should choose a name for the package and put a **package** statement with that name at the top of every source file that contains the classes, interfaces, enumerations, and annotation types that you want to include in the package.

The **package** statement should be the first line in the source file. There can be only one package statement in each source file, and it applies to all types in the file.

If a package statement is not used then the class, interfaces, enumerations, and annotation types will be put into an unnamed package.

Example:

Let us look at an example that creates a package called **animals**. It is common practice to use lowercased names of packages to avoid any conflicts with the names of classes, interfaces.

Put an interface in the package *animals*:

```
/* File name : Animal.java */
package animals;

interface Animal{
public void eat();
}
```

TUTORIALS POINT

Simply Easy Learning

```
public void travel();
}
```

Now, put an implementation in the same package *animals*:

```
package animals;

/* File name : MammalInt.java */
public class MammalInt implements Animal{

public void eat(){
System.out.println("Mammal eats");
}

public void travel(){
System.out.println("Mammal travels");
}

public int noOfLegs(){
return 0;
}

public static void main(String args[]){
MammalInt m =new MammalInt();
m.eat();
m.travel();
}
}
```

Now, you compile these two files and put them in a sub-directory called **animals** and try to run as follows:

```
$ mkdir animals
$ cp Animal.classMammalInt.class animals
$ java animals/MammalInt
Mammal eats
Mammal travels
```

The import Keyword:

If a class wants to use another class in the same package, the package name does not need to be used. Classes in the same package find each other without any special syntax.

Example:

Here, a class named Boss is added to the payroll package that already contains Employee. The Boss can then refer to the Employee class without using the payroll prefix, as demonstrated by the following Boss class.

```
package payroll;

public class Boss
{
public void payEmployee(Employee e)
{
e.mailCheck();
}
}
```

What happens if Boss is not in the payroll package? The Boss class must then use one of the following techniques for referring to a class in a different package.

- The fully qualified name of the class can be used. For example:

```
payroll.Employee
```

- The package can be imported using the import keyword and the wild card (*). For example:

```
import payroll.*;
```

- The class itself can be imported using the import keyword. For example:

```
import payroll.Employee;
```

Note: A class file can contain any number of import statements. The import statements must appear after the package statement and before the class declaration.

The Directory Structure of Packages:

Two major results occur when a class is placed in a package:

- The name of the package becomes a part of the name of the class, as we just discussed in the previous section.
- The name of the package must match the directory structure where the corresponding bytecode resides.

Here is simple way of managing your files in Java:

Put the source code for a class, interface, enumeration, or annotation type in a text file whose name is the simple name of the type and whose extension is **.java**. For example:

```
// File Name : Car.java

package vehicle;

public class Car{
// Class implementation.
}
```

Now, put the source file in a directory whose name reflects the name of the package to which the class belongs:

```
...\vehicle\Car.java
```

Now, the qualified class name and pathname would be as below:

- Class name -> vehicle.Car
- Path name -> vehicle\Car.java (in windows)

In general, a company uses its reversed Internet domain name for its package names. Example: A company's Internet domain name is apple.com, then all its package names would start with com.apple. Each component of the package name corresponds to a subdirectory.

Example: The company had a com.apple.computers package that contained a Dell.java source file, it would be contained in a series of subdirectories like this:

```
...\com\apple\computers\Dell.java
```

At the time of compilation, the compiler creates a different output file for each class, interface and enumeration defined in it. The base name of the output file is the name of the type, and its extension is **.class**

For example:

```
// File Name: Dell.java

package com.apple.computers;
public class Dell{

}

class Ups{

}
```

Now, compile this file as follows using -d option:

```
$javac -d .Dell.java
```

This would put compiled files as follows:

```
.\com\apple\computers\Dell.class
.\com\apple\computers\Ups.class
```

You can import all the classes or interfaces defined in `\com\apple\computers\` as follows:

```
import com.apple.computers.*;
```

Like the .java source files, the compiled .class files should be in a series of directories that reflect the package name. However, the path to the .class files does not have to be the same as the path to the .java source files. You can arrange your source and class directories separately, as:

```
<path-one>\sources\com\apple\computers\Dell.java
<path-two>\classes\com\apple\computers\Dell.class
```

By doing this, it is possible to give the classes directory to other programmers without revealing your sources. You also need to manage source and class files in this manner so that the compiler and the Java Virtual Machine (JVM) can find all the types your program uses.

The full path to the classes directory, `<path-two>\classes`, is called the class path, and is set with the CLASSPATH system variable. Both the compiler and the JVM construct the path to your .class files by adding the package name to the class path.

Say `<path-two>\classes` is the class path, and the package name is `com.apple.computers`, then the compiler and JVM will look for .class files in `<path-two>\classes\com\apple\compters`.

A class path may include several paths. Multiple paths should be separated by a semicolon (Windows) or colon (UNIX). By default, the compiler and the JVM search the current directory and the JAR file containing the Java platform classes so that these directories are automatically in the class path.

Set CLASSPATH System Variable:

To display the current CLASSPATH variable, use the following commands in Windows and UNIX (Bourne shell):

- In Windows -> `C:\> set CLASSPATH`

- In UNIX -> % echo \$CLASSPATH

To delete the current contents of the CLASSPATH variable, use:

- In Windows -> C:\> set CLASSPATH=
- In UNIX -> % unset CLASSPATH; export CLASSPATH

To set the CLASSPATH variable:

- In Windows -> set CLASSPATH=C:\users\jack\java\classes
- In UNIX -> % CLASSPATH=/home/jack/java/classes; export CLASSPATH

Java Data Structures

The data structures provided by the Java utility package are very powerful and perform a wide range of functions. These data structures consist of the following interface and classes:

- Enumeration
- BitSet
- Vector
- Stack
- Dictionary
- Hashtable
- Properties

All these classes are now legacy and Java-2 has introduced a new framework called Collections Framework, which is discussed in next tutorial:

The Enumeration:

The Enumeration interface isn't itself a data structure, but it is very important within the context of other data structures. The Enumeration interface defines a means to retrieve successive elements from a data structure.

For example, Enumeration defines a method called `nextElement` that is used to get the next element in a data structure that contains multiple elements.

The Enumeration interface defines the methods by which you can enumerate (obtain one at a time) the elements in a collection of objects.

This legacy interface has been superceded by `Iterator`. Although not deprecated, Enumeration is considered obsolete for new code. However, it is used by several methods defined by the legacy classes such as `Vector` and `Properties`, is used by several other API classes, and is currently in widespread use in application code.

The methods declared by Enumeration are summarized in the following table:

SN	Methods with Description
1	boolean hasMoreElements() When implemented, it must return true while there are still more elements to extract, and false when all the elements have been enumerated.
2	Object nextElement() This returns the next object in the enumeration as a generic Object reference.

Example:

Following is the example showing usage of Enumeration.

```
import java.util.Vector;
import java.util.Enumeration;

public class EnumerationTester{

public static void main(String args[]){
Enumeration days;
Vector dayNames =newVector();
dayNames.add("Sunday");
    dayNames.add("Monday");
    dayNames.add("Tuesday");
    dayNames.add("Wednesday");
    dayNames.add("Thursday");
    dayNames.add("Friday");
    dayNames.add("Saturday");
    days = dayNames.elements();
while(days.hasMoreElements()){
System.out.println(days.nextElement());
}
}
}
```

This would produce the following result:

```
Sunday
Monday
Tuesday
Wednesday
Thursday
Friday
Saturday
```

The BitSet

The BitSet class implements a group of bits or flags that can be set and cleared individually.

This class is very useful in cases, where you need to keep up with a set of Boolean values; you just assign a bit to each value and set or clear it as appropriate.

A BitSet class creates a special type of array that holds bit values. The BitSet array can increase in size as needed. This makes it similar to a vector of bits.

This is a legacy class but it has been completely re-engineered in Java 2, version 1.4.

The BitSet defines two constructors. The first version creates a default object:

```
BitSet()
```

The second version allows you to specify its initial size, i.e., the number of bits that it can hold. All bits are initialized to zero.

```
BitSet(int size)
```

BitSet implements the Cloneable interface and defines the methods listed in table below:

SN	Methods with Description
1	void and(BitSet bitSet) ANDs the contents of the invoking BitSet object with those specified by bitSet. The result is placed into the invoking object.
2	void andNot(BitSet bitSet) For each 1 bit in bitSet, the corresponding bit in the invoking BitSet is cleared.
3	int cardinality() Returns the number of set bits in the invoking object.
4	void clear() Zeros all bits.
5	void clear(int index) Zeros the bit specified by index.
6	void clear(int startIndex, int endIndex) Zeros the bits from startIndex to endIndex.1.
7	Object clone() Duplicates the invoking BitSet object.
8	boolean equals(Object bitSet) Returns true if the invoking bit set is equivalent to the one passed in bitSet. Otherwise, the method returns false.
9	void flip(int index) Reverses the bit specified by index. (
10	void flip(int startIndex, int endIndex) Reverses the bits from startIndex to endIndex.1.
11	boolean get(int index) Returns the current state of the bit at the specified index.
12	BitSet get(int startIndex, int endIndex) Returns a BitSet that consists of the bits from startIndex to endIndex.1. The invoking object is not changed.
13	int hashCode() Returns the hash code for the invoking object.
14	boolean intersects(BitSet bitSet) Returns true if at least one pair of corresponding bits within the invoking object and bitSet are 1.
15	boolean isEmpty() Returns true if all bits in the invoking object are zero.
16	int length() Returns the number of bits required to hold the contents of the invoking BitSet. This value is

	determined by the location of the last 1 bit.
17	int nextClearBit(int startIndex) Returns the index of the next cleared bit, (that is, the next zero bit), starting from the index specified by startIndex
18	int nextSetBit(int startIndex) Returns the index of the next set bit (that is, the next 1 bit), starting from the index specified by startIndex. If no bit is set, -1 is returned.
19	void or(BitSet bitSet) ORs the contents of the invoking BitSet object with that specified by bitSet. The result is placed into the invoking object.
20	void set(int index) Sets the bit specified by index.
21	void set(int index, boolean v) Sets the bit specified by index to the value passed in v. true sets the bit, false clears the bit.
22	void set(int startIndex, int endIndex) Sets the bits from startIndex to endIndex-1.
23	void set(int startIndex, int endIndex, boolean v) Sets the bits from startIndex to endIndex-1, to the value passed in v. true sets the bits, false clears the bits.
24	int size() Returns the number of bits in the invoking BitSet object.
25	String toString() Returns the string equivalent of the invoking BitSet object.
26	void xor(BitSet bitSet) XORs the contents of the invoking BitSet object with that specified by bitSet. The result is placed into the invoking object

Example:

The following program illustrates several of the methods supported by this data structure:

```
import java.util.BitSet;

public class BitSetDemo{

public static void main(String args[]){
BitSet bits1 =new BitSet(16);
BitSet bits2 =new BitSet(16);

// set some bits
for(int i=0; i<16; i++){
if((i%2)==0) bits1.set(i);
if((i%5)!=0) bits2.set(i);
}
System.out.println("Initial pattern in bits1: ");
System.out.println(bits1);
System.out.println("\nInitial pattern in bits2: ");
System.out.println(bits2);

// AND bits
bits2.and(bits1);
```

```

System.out.println("\nbits2 AND bits1: ");
System.out.println(bits2);

// OR bits
bits2.or(bits1);
System.out.println("\nbits2 OR bits1: ");
System.out.println(bits2);

// XOR bits
bits2.xor(bits1);
System.out.println("\nbits2 XOR bits1: ");
System.out.println(bits2);
}
}

```

This would produce the following result:

```

Initial pattern in bits1:
{0,2,4,6,8,10,12,14}

Initial pattern in bits2:
{1,2,3,4,6,7,8,9,11,12,13,14}

bits2 AND bits1:
{2,4,6,8,12,14}

bits2 OR bits1:
{0,2,4,6,8,10,12,14}

bits2 XOR bits1:
{}

```

The Vector

The Vector class is similar to a traditional Java array, except that it can grow as necessary to accommodate new elements.

Like an array, elements of a Vector object can be accessed via an index into the vector.

The nice thing about using the Vector class is that you don't have to worry about setting it to a specific size upon creation; it shrinks and grows automatically when necessary.

Vector implements a dynamic array. It is similar to ArrayList, but with two differences:

- Vector is synchronized.
- Vector contains many legacy methods that are not part of the collections framework.

Vector proves to be very useful if you don't know the size of the array in advance or you just need one that can change sizes over the lifetime of a program.

The Vector class supports four constructors. The first form creates a default vector, which has an initial size of 10:

```
Vector()
```

The second form creates a vector whose initial capacity is specified by size:

```
Vector(int size)
```

The third form creates a vector whose initial capacity is specified by size and whose increment is specified by incr. The increment specifies the number of elements to allocate each time that a vector is resized upward:

```
Vector(int size,int incr)
```

The fourth form creates a vector that contains the elements of collection c:

```
Vector(Collection c)
```

Apart from the methods inherited from its parent classes, Vector defines the following methods:

SN	Methods with Description
1	void add(int index, Object element) Inserts the specified element at the specified position in this Vector.
2	boolean add(Object o) Appends the specified element to the end of this Vector.
3	boolean addAll(Collection c) Appends all of the elements in the specified Collection to the end of this Vector, in the order that they are returned by the specified Collection's Iterator.
4	boolean addAll(int index, Collection c) Inserts all of the elements in in the specified Collection into this Vector at the specified position.
5	void addElement(Object obj) Adds the specified component to the end of this vector, increasing its size by one.
6	int capacity() Returns the current capacity of this vector.
7	void clear() Removes all of the elements from this Vector.
8	Object clone() Returns a clone of this vector.
9	boolean contains(Object elem) Tests if the specified object is a component in this vector.
10	boolean containsAll(Collection c) Returns true if this Vector contains all of the elements in the specified Collection.
11	void copyInto(Object[] anArray) Copies the components of this vector into the specified array.
12	Object elementAt(int index) Returns the component at the specified index.
13	Enumeration elements() Returns an enumeration of the components of this vector.
14	void ensureCapacity(int minCapacity) Increases the capacity of this vector, if necessary, to ensure that it can hold at least the number of components specified by the minimum capacity argument.
15	boolean equals(Object o) Compares the specified Object with this Vector for equality.

16	Object firstElement() Returns the first component (the item at index 0) of this vector.
17	Object get(int index) Returns the element at the specified position in this Vector.
18	int hashCode() Returns the hash code value for this Vector.
19	int indexOf(Object elem) Searches for the first occurrence of the given argument, testing for equality using the equals method.
20	int indexOf(Object elem, int index) Searches for the first occurrence of the given argument, beginning the search at index, and testing for equality using the equals method.
21	void insertElementAt(Object obj, int index) Inserts the specified object as a component in this vector at the specified index.
22	boolean isEmpty() Tests if this vector has no components.
23	Object lastElement() Returns the last component of the vector.
24	int lastIndexOf(Object elem) Returns the index of the last occurrence of the specified object in this vector.
25	int lastIndexOf(Object elem, int index) Searches backwards for the specified object, starting from the specified index, and returns an index to it.
26	Object remove(int index) Removes the element at the specified position in this Vector.
27	boolean remove(Object o) Removes the first occurrence of the specified element in this Vector. If the Vector does not contain the element, it is unchanged.
28	boolean removeAll(Collection c) Removes from this Vector all of its elements that are contained in the specified Collection.
29	void removeAllElements() Removes all components from this vector and sets its size to zero.
30	boolean removeElement(Object obj) Removes the first (lowest-indexed) occurrence of the argument from this vector.
31	void removeElementAt(int index) removeElementAt(int index)
32	protected void removeRange(int fromIndex, int toIndex) Removes from this List all of the elements whose index is between fromIndex, inclusive and toIndex, exclusive.
33	boolean retainAll(Collection c) Retains only the elements in this Vector that are contained in the specified Collection.
34	Object set(int index, Object element) Replaces the element at the specified position in this Vector with the specified element.

35	void setElementAt(Object obj, int index) Sets the component at the specified index of this vector to be the specified object.
36	void setSize(int newSize) Sets the size of this vector.
37	int size() Returns the number of components in this vector.
38	List subList(int fromIndex, int toIndex) Returns a view of the portion of this List between fromIndex, inclusive, and toIndex, exclusive.
39	Object[] toArray() Returns an array containing all of the elements in this Vector in the correct order.
40	Object[] toArray(Object[] a) Returns an array containing all of the elements in this Vector in the correct order; the runtime type of the returned array is that of the specified array.
41	String toString() Returns a string representation of this Vector, containing the String representation of each element.
42	void trimToSize() Trims the capacity of this vector to be the vector's current size.

Example:

The following program illustrates several of the methods supported by this collection:

```
import java.util.*;

public class VectorDemo{

public static void main(String args[]){
// initial size is 3, increment is 2
Vector v =new Vector(3,2);
System.out.println("Initial size: "+ v.size());
System.out.println("Initial capacity: "+v.capacity());
    v.addElement(new Integer(1));
v.addElement(new Integer(2));
    v.addElement(new Integer(3));
    v.addElement(new Integer(4));
System.out.println("Capacity after four additions: "+v.capacity());

v.addElement(new Double(5.45));
System.out.println("Current capacity: "+v.capacity());
    v.addElement(new Double(6.08));
    v.addElement(new Integer(7));
System.out.println("Current capacity: "+v.capacity());
v.addElement(new Float(9.4));
    v.addElement(new Integer(10));
System.out.println("Current capacity: "+v.capacity());
v.addElement(new Integer(11));
    v.addElement(new Integer(12));
System.out.println("First element: "+(Integer)v.firstElement());
System.out.println("Last element: "+(Integer)v.lastElement());
if(v.contains(new Integer(3)))
System.out.println("Vector contains 3.");
// enumerate the elements in the vector.
Enumeration vEnum = v.elements();
```

TUTORIALS POINT

Simply Easy Learning

```

System.out.println("\nElements in vector:");
while (vEnum.hasMoreElements())
System.out.print (vEnum.nextElement()+" ");
System.out.println();
}
}

```

This would produce the following result:

```

Initial size:0
Initial capacity:3
Capacity after four additions:5
Current capacity:5
Current capacity:7
Current capacity:9
First element:1
Last element:12
Vector contains 3.

Elements in vector:
12345.456.0879.4101112

```

The Stack

The Stack class implements a last-in-first-out (LIFO) stack of elements.

You can think of a stack literally as a vertical stack of objects; when you add a new element, it gets stacked on top of the others.

When you pull an element off the stack, it comes off the top. In other words, the last element you added to the stack is the first one to come back off.

Stack is a subclass of Vector that implements a standard last-in, first-out stack.

Stack only defines the default constructor, which creates an empty stack. Stack includes all the methods defined by Vector and adds several of its own.

```
Stack()
```

Apart from the methods inherited from its parent class Vector, Stack defines the following methods:

SN	Methods with Description
1	boolean empty() Tests if this stack is empty. Returns true if the stack is empty, and returns false if the stack contains elements.
2	Object peek() Returns the element on the top of the stack, but does not remove it.
3	Object pop() Returns the element on the top of the stack, removing it in the process.
4	Object push(Object element) Pushes element onto the stack. element is also returned.
5	int search(Object element) Searches for element in the stack. If found, its offset from the top of the stack is returned.

Otherwise, .1 is returned.

Example:

The following program illustrates several of the methods supported by this collection:

```
import java.util.*;

public class StackDemo{

    static void showpush(Stack st,int a){
        st.push(new Integer(a));
        System.out.println("push("+ a +")");
        System.out.println("stack: "+ st);
    }

    static void showpop(Stack st){
        System.out.print("pop -> ");
        Integer a =(Integer) st.pop();
        System.out.println(a);
        System.out.println("stack: "+ st);
    }

    public static void main(String args[]){
        Stack st =new Stack();
        System.out.println("stack: "+ st);
        showpush(st,42);
        showpush(st,66);
        showpush(st,99);
        showpop(st);
        showpop(st);
        showpop(st);
        try{
            showpop(st);
        }catch(EmptyStackException e){
            System.out.println("empty stack");
        }
    }
}
```

This would produce the following result:

```
stack: []
push (42)
stack: [42]
push (66)
stack: [42, 66]
push (99)
stack: [42, 66, 99]
pop ->99
stack: [42, 66]
pop ->66
stack: [42]
pop ->42
stack: []
pop -> empty stack
```

The Dictionary

The Dictionary class is an abstract class that defines a data structure for mapping keys to values.

This is useful in cases where you want to be able to access data via a particular key rather than an integer index.

Since the Dictionary class is abstract, it provides only the framework for a key-mapped data structure rather than a specific implementation.

Dictionary is an abstract class that represents a key/value storage repository and operates much like Map.

Given a key and value, you can store the value in a Dictionary object. Once the value is stored, you can retrieve it by using its key. Thus, like a map, a dictionary can be thought of as a list of key/value pairs.

The abstract methods defined by Dictionary are listed below:

SN	Methods with Description
1	Enumeration elements() Returns an enumeration of the values contained in the dictionary.
2	Object get(Object key) Returns the object that contains the value associated with key. If key is not in the dictionary, a null object is returned.
3	boolean isEmpty() Returns true if the dictionary is empty, and returns false if it contains at least one key.
4	Enumeration keys() Returns an enumeration of the keys contained in the dictionary.
5	Object put(Object key, Object value) Inserts a key and its value into the dictionary. Returns null if key is not already in the dictionary; returns the previous value associated with key if key is already in the dictionary.
6	Object remove(Object key) Removes key and its value. Returns the value associated with key. If key is not in the dictionary, a null is returned.
7	int size() Returns the number of entries in the dictionary.

The Dictionary class is obsolete. You should implement the [Map interface](#) to obtain key/value storage functionality.

Map Interface

The Map interface maps unique keys to values. A key is an object that you use to retrieve a value at a later date.

- Given a key and a value, you can store the value in a Map object. After the value is stored, you can retrieve it by using its key.
- Several methods throw a NoSuchElementException when no items exist in the invoking map.
- A ClassCastException is thrown when an object is incompatible with the elements in a map.
- A ClassCastException is thrown when an object is incompatible with the elements in a map.

- A `NullPointerException` is thrown if an attempt is made to use a null object and null is not allowed in the map.
- An `UnsupportedOperationException` is thrown when an attempt is made to change an unmodifiable map.

SN	Methods with Description
1	void clear() Removes all key/value pairs from the invoking map.
2	boolean containsKey(Object k) Returns true if the invoking map contains k as a key. Otherwise, returns false.
3	boolean containsValue(Object v) Returns true if the map contains v as a value. Otherwise, returns false.
4	Set entrySet() Returns a Set that contains the entries in the map. The set contains objects of type <code>Map.Entry</code> . This method provides a set-view of the invoking map.
5	boolean equals(Object obj) Returns true if obj is a Map and contains the same entries. Otherwise, returns false.
6	Object get(Object k) Returns the value associated with the key k.
7	int hashCode() Returns the hash code for the invoking map.
8	boolean isEmpty() Returns true if the invoking map is empty. Otherwise, returns false.
9	Set keySet() Returns a Set that contains the keys in the invoking map. This method provides a set-view of the keys in the invoking map.
10	Object put(Object k, Object v) Puts an entry in the invoking map, overwriting any previous value associated with the key. The key and value are k and v, respectively. Returns null if the key did not already exist. Otherwise, the previous value linked to the key is returned.
11	void putAll(Map m) Puts all the entries from m into this map.
12	Object remove(Object k) Removes the entry whose key equals k.
13	int size() Returns the number of key/value pairs in the map.
14	Collection values() Returns a collection containing the values in the map. This method provides a collection-view of the values in the map.

Example:

Map has its implementation in various classes like `HashMap`, Following is the example to explain map functionality:

```
import java.util.*;

public class CollectionsDemo{
```

TUTORIALS POINT

Simply Easy Learning

```

public static void main(String[] args){
    Map m1 =new HashMap();
    m1.put("Zara","8");
    m1.put("Mahnaz","31");
    m1.put("Ayan","12");
    m1.put("Daisy","14");
    System.out.println();
    System.out.println(" Map Elements");
    System.out.print("\t"+ m1);
}
}

```

This would produce the following result:

```

MapElements
{Mahnaz=31,Ayan=12,Daisy=14,Zara=8}

```

The Hashtable

The Hashtable class provides a means of organizing data based on some user-defined key structure.

For example, in an address list hash table you could store and sort data based on a key such as ZIP code rather than on a person's name.

The specific meaning of keys in regard to hashtables is totally dependent on the usage of the hashtable and the data it contains.

Hashtable was part of the original java.util and is a concrete implementation of a Dictionary.

However, Java 2 reengineered Hashtable so that it also implements the Map interface. Thus, Hashtable is now integrated into the collections framework. It is similar to HashMap, but is synchronized.

Like HashMap, Hashtable stores key/value pairs in a hashtable. When using a Hashtable, you specify an object that is used as a key, and the value that you want linked to that key. The key is then hashed, and the resulting hash code is used as the index at which the value is stored within the table.

The Hashtable defines four constructors. The first version is the default constructor:

```

Hashtable()

```

The second version creates a hashtable that has an initial size specified by size:

```

Hashtable(int size)

```

The third version creates a hashtable that has an initial size specified by size and a fill ratio specified by fillRatio.

This ratio must be between 0.0 and 1.0, and it determines how full the hashtable can be before it is resized upward.

```

Hashtable(int size,float fillRatio)

```

The fourth version creates a hashtable that is initialized with the elements in m.

The capacity of the hashtable is set to twice the number of elements in m. The default load factor of 0.75 is used.

```

Hashtable(Map m)

```

Apart from the methods defined by Map interface, Hashtable defines the following methods:

TUTORIALS POINT

Simply Easy Learning

SN	Methods with Description
1	void clear() Resets and empties the hash table.
2	Object clone() Returns a duplicate of the invoking object.
3	boolean contains(Object value) Returns true if some value equal to value exists within the hash table. Returns false if the value isn't found.
4	boolean containsKey(Object key) Returns true if some key equal to key exists within the hash table. Returns false if the key isn't found.
5	boolean containsValue(Object value) Returns true if some value equal to value exists within the hash table. Returns false if the value isn't found.
6	Enumeration elements() Returns an enumeration of the values contained in the hash table.
7	Object get(Object key) Returns the object that contains the value associated with key. If key is not in the hash table, a null object is returned.
8	boolean isEmpty() Returns true if the hash table is empty; returns false if it contains at least one key.
9	Enumeration keys() Returns an enumeration of the keys contained in the hash table.
10	Object put(Object key, Object value) Inserts a key and a value into the hash table. Returns null if key isn't already in the hash table; returns the previous value associated with key if key is already in the hash table.
11	void rehash() Increases the size of the hash table and rehashes all of its keys.
12	Object remove(Object key) Removes key and its value. Returns the value associated with key. If key is not in the hash table, a null object is returned.
13	int size() Returns the number of entries in the hash table.
14	String toString() Returns the string equivalent of a hash table.

Example:

The following program illustrates several of the methods supported by this data structure:

```
import java.util.*;

public class HashTableDemo{

public static void main(String args[]){
// Create a hash map
Hashtable balance =new Hashtable();
```

TUTORIALS POINT

Simply Easy Learning

```

Enumeration names;
String str;
double bal;

    balance.put("Zara",new Double(3434.34));
    balance.put("Mahnaz",new Double(123.22));
    balance.put("Ayan",new Double(1378.00));
    balance.put("Daisy",new Double(99.22));
    balance.put("Qadir",new Double(-19.08));

// Show all balances in hash table.
names = balance.keys();
while(names.hasMoreElements()){
str =(String) names.nextElement();
System.out.println(str +": "+balance.get(str));
}
System.out.println();
// Deposit 1,000 into Zara's account
    bal =((Double)balance.get("Zara")).doubleValue();
    balance.put("Zara",new Double(bal+1000));
System.out.println("Zara's new balance: "+balance.get("Zara"));
}
}

```

This would produce the following result:

```

Qadir:-19.08
Zara:3434.34
Mahnaz:123.22
Daisy:99.22
Ayan:1378.0

Zara's new balance: 4434.34

```

The Properties

Properties is a subclass of Hashtable. It is used to maintain lists of values in which the key is a String and the value is also a String.

The Properties class is used by many other Java classes. For example, it is the type of object returned by System.getProperties() when obtaining environmental values.

Properties is a subclass of Hashtable. It is used to maintain lists of values in which the key is a String and the value is also a String.

The Properties class is used by many other Java classes. For example, it is the type of object returned by System.getProperties() when obtaining environmental values.

Properties define the following instance variable. This variable holds a default property list associated with a Properties object.

```

Properties defaults;

```

The Properties define two constructors. The first version creates a Properties object that has no default values:

```

Properties()

```

The second creates an object that uses propDefault for its default values. In both cases, the property list is empty:

TUTORIALS POINT

Simply Easy Learning

```
Properties(Properties propDefault)
```

Apart from the methods defined by Hashtable, Properties define the following methods:

SN	Methods with Description
1	String getProperty(String key) Returns the value associated with key. A null object is returned if key is neither in the list nor in the default property list.
2	String getProperty(String key, String defaultProperty) Returns the value associated with key. defaultProperty is returned if key is neither in the list nor in the default property list.
3	void list(PrintStream streamOut) Sends the property list to the output stream linked to streamOut.
4	void list(PrintWriter streamOut) Sends the property list to the output stream linked to streamOut.
5	void load(InputStream streamIn) throws IOException Inputs a property list from the input stream linked to streamIn.
6	Enumeration propertyNames() Returns an enumeration of the keys. This includes those keys found in the default property list, too.
7	Object setProperty(String key, String value) Associates value with key. Returns the previous value associated with key, or returns null if no such association exists.
8	void store(OutputStream streamOut, String description) After writing the string specified by description, the property list is written to the output stream linked to streamOut.

Example:

The following program illustrates several of the methods supported by this data structure:

```
import java.util.*;

public class PropDemo{

public static void main(String args[]){
Properties capitals =new Properties();
Set states;
String str;

    capitals.put("Illinois","Springfield");
    capitals.put("Missouri","Jefferson City");
    capitals.put("Washington","Olympia");
    capitals.put("California","Sacramento");
    capitals.put("Indiana","Indianapolis");

// Show all states and capitals in hashtable.
    states = capitals.keySet();// get set-view of keys
    Iterator itr = states.iterator();
    while(itr.hasNext()){
        str =(String) itr.next();
        System.out.println("The capital of "+str +" is "+capitals.getProperty(str)+".");
    }
}
```

TUTORIALS POINT

Simply Easy Learning

```
System.out.println();

// look for state not in list -- specify default
str = capitals.getProperty("Florida","Not Found");
System.out.println("The capital of Florida is "+ str +".");
}
}
```

This would produce the following result:

```
The capital of Missouri is JeffersonCity.
The capital of Illinois is Springfield.
The capital of Indiana is Indianapolis.
The capital of California is Sacramento.
The capital of Washington is Olympia.

The capital of Florida is NotFound.
```

Java Collections

Prior to Java 2, Java provided ad hoc classes such as **Dictionary**, **Vector**, **Stack**, and **Properties** to store and manipulate groups of objects. Although these classes were quite useful, they lacked a central, unifying theme. Thus, the way that you used **Vector** was different from the way that you used **Properties**.

The collections framework was designed to meet several goals.

- The framework had to be high-performance. The implementations for the fundamental collections (dynamic arrays, linked lists, trees, and hashtables) are highly efficient.
- The framework had to allow different types of collections to work in a similar manner and with a high degree of interoperability.
- Extending and/or adapting a collection had to be easy.

Towards this end, the entire collections framework is designed around a set of standard interfaces. Several standard implementations such as **LinkedList**, **HashSet**, and **TreeSet**, of these interfaces are provided that you may use as-is and you may also implement your own collection, if you choose.

A collections framework is a unified architecture for representing and manipulating collections. All collections frameworks contain the following:

- **Interfaces:** These are abstract data types that represent collections. Interfaces allow collections to be manipulated independently of the details of their representation. In object-oriented languages, interfaces generally form a hierarchy.
- **Implementations, i.e., Classes:** These are the concrete implementations of the collection interfaces. In essence, they are reusable data structures.
- **Algorithms:** These are the methods that perform useful computations, such as searching and sorting, on objects that implement collection interfaces. The algorithms are said to be polymorphic: that is, the same method can be used on many different implementations of the appropriate collection interface.

In addition to collections, the framework defines several map interfaces and classes. Maps store key/value pairs. Although maps are not *collections* in the proper use of the term, but they are fully integrated with collections.

The Collection Interfaces:

The collections framework defines several interfaces. This section provides an overview of each interface:

SN	Interfaces with Description
----	-----------------------------

1	The Collection Interface This enables you to work with groups of objects; it is at the top of the collections hierarchy.
2	The List Interface This extends Collection and an instance of List stores an ordered collection of elements.
3	The Set This extends Collection to handle sets, which must contain unique elements
4	The SortedSet This extends Set to handle sorted sets
5	The Map This maps unique keys to values.
6	The Map.Entry This describes an element (a key/value pair) in a map. This is an inner class of Map.
7	The SortedMap This extends Map so that the keys are maintained in ascending order.
8	The Enumeration This is legacy interface and defines the methods by which you can enumerate (obtain one at a time) the elements in a collection of objects. This legacy interface has been superceded by Iterator.

The Collection Classes:

Java provides a set of standard collection classes that implement Collection interfaces. Some of the classes provide full implementations that can be used as-is and others are abstract class, providing skeletal implementations that are used as starting points for creating concrete collections.

The standard collection classes are summarized in the following table:

SN	Classes with Description
1	AbstractCollection Implements most of the Collection interface.
2	AbstractList Extends AbstractCollection and implements most of the List interface.
3	AbstractSequentialList Extends AbstractList for use by a collection that uses sequential rather than random access of its elements.
4	LinkedList Implements a linked list by extending AbstractSequentialList.
5	ArrayList Implements a dynamic array by extending AbstractList.
6	AbstractSet Extends AbstractCollection and implements most of the Set interface.
7	HashSet Extends AbstractSet for use with a hash table.
8	LinkedHashSet Extends HashSet to allow insertion-order iterations.

9	TreeSet Implements a set stored in a tree. Extends AbstractSet.
10	AbstractMap Implements most of the Map interface.
11	HashMap Extends AbstractMap to use a hash table.
12	TreeMap Extends AbstractMap to use a tree.
13	WeakHashMap Extends AbstractMap to use a hash table with weak keys.
14	LinkedHashMap Extends HashMap to allow insertion-order iterations.
15	IdentityHashMap Extends AbstractMap and uses reference equality when comparing documents.

The *AbstractCollection*, *AbstractSet*, *AbstractList*, *AbstractSequentialList* and *AbstractMap* classes provide skeletal implementations of the core collection interfaces, to minimize the effort required to implement them.

The following legacy classes defined by java.util have been discussed in previous tutorial:

SN	Classes with Description
1	Vector This implements a dynamic array. It is similar to ArrayList, but with some differences.
2	Stack Stack is a subclass of Vector that implements a standard last-in, first-out stack.
3	Dictionary Dictionary is an abstract class that represents a key/value storage repository and operates much like Map.
4	Hashtable Hashtable was part of the original java.util and is a concrete implementation of a Dictionary.
5	Properties Properties is a subclass of Hashtable. It is used to maintain lists of values in which the key is a String and the value is also a String.
6	BitSet A BitSet class creates a special type of array that holds bit values. This array can increase in size as needed.

The Collection Algorithms:

The collections framework defines several algorithms that can be applied to collections and maps. These algorithms are defined as static methods within the Collections class.

Several of the methods can throw a **ClassCastException**, which occurs when an attempt is made to compare incompatible types, or an **UnsupportedOperationException**, which occurs when an attempt is made to modify an unmodifiable collection.

Collections define three static variables: EMPTY_SET, EMPTY_LIST, and EMPTY_MAP. All are immutable.

SN	Algorithms with Description
1	The Collection Algorithms Here is a list of all the algorithm implementation.

How to use an Iterator?

Often, you will want to cycle through the elements in a collection. For example, you might want to display each element.

The easiest way to do this is to employ an iterator, which is an object that implements either the Iterator or the ListIterator interface.

Iterator enables you to cycle through a collection, obtaining or removing elements. ListIterator extends Iterator to allow bidirectional traversal of a list and the modification of elements.

SN	Iterator Methods with Description
1	Using Java Iterator Here is a list of all the methods with examples provided by Iterator and ListIterator interfaces.

Using Java Iterator

Often, you will want to cycle through the elements in a collection. For example, you might want to display each element.

The easiest way to do this is to employ an iterator, which is an object that implements either the Iterator or the ListIterator interface.

Iterator enables you to cycle through a collection, obtaining or removing elements. ListIterator extends Iterator to allow bidirectional traversal of a list, and the modification of elements.

Before you can access a collection through an iterator, you must obtain one. Each of the collection classes provides an iterator() method that returns an iterator to the start of the collection. By using this iterator object, you can access each element in the collection, one element at a time.

In general, to use an iterator to cycle through the contents of a collection, follow these steps:

- Obtain an iterator to the start of the collection by calling the collection's iterator() method.
- Set up a loop that makes a call to hasNext(). Have the loop iterate as long as hasNext() returns true.
- Within the loop, obtain each element by calling next().

For collections that implement List, you can also obtain an iterator by calling ListIterator.

The Methods Declared by Iterator:

SN	Methods with Description
1	boolean hasNext() Returns true if there are more elements. Otherwise, returns false.
2	Object next()

	Returns the next element. Throws NoSuchElementException if there is not a next element.
3	void remove() Removes the current element. Throws IllegalStateException if an attempt is made to call remove() that is not preceded by a call to next().

The Methods Declared by ListIterator:

SN	Methods with Description
1	void add(Object obj) Inserts obj into the list in front of the element that will be returned by the next call to next().
2	boolean hasNext() Returns true if there is a next element. Otherwise, returns false.
3	boolean hasPrevious() Returns true if there is a previous element. Otherwise, returns false.
4	Object next() Returns the next element. A NoSuchElementException is thrown if there is not a next element.
5	int nextIndex() Returns the index of the next element. If there is not a next element, returns the size of the list.
6	Object previous() Returns the previous element. A NoSuchElementException is thrown if there is not a previous element.
7	int previousIndex() Returns the index of the previous element. If there is not a previous element, returns -1.
8	void remove() Removes the current element from the list. An IllegalStateException is thrown if remove() is called before next() or previous() is invoked.
9	void set(Object obj) Assigns obj to the current element. This is the element last returned by a call to either next() or previous().

Example:

Here is an example demonstrating both Iterator and ListIterator. It uses an ArrayList object, but the general principles apply to any type of collection.

Of course, ListIterator is available only to those collections that implement the List interface.

```
import java.util.*;

public class IteratorDemo {

    public static void main(String args[]) {
        // Create an array list
        ArrayList al = new ArrayList();
        // add elements to the array list
        al.add("C");
        al.add("A");
        al.add("E");
        al.add("B");
        al.add("D");
    }
}
```

```
al.add("F");

// Use iterator to display contents of al
System.out.print("Original contents of al: ");
Iterator itr = al.iterator();
while(itr.hasNext()) {
    Object element = itr.next();
    System.out.print(element + " ");
}
System.out.println();

// Modify objects being iterated
ListIterator litr = al.listIterator();
while(litr.hasNext()) {
    Object element = litr.next();
    litr.set(element + "+");
}
System.out.print("Modified contents of al: ");
itr = al.iterator();
while(itr.hasNext()) {
    Object element = itr.next();
    System.out.print(element + " ");
}
System.out.println();

// Now, display the list backwards
System.out.print("Modified list backwards: ");
while(litr.hasPrevious()) {
    Object element = litr.previous();
    System.out.print(element + " ");
}
System.out.println();
}
```

This would produce the following result:

```
Original contents of al: C A E B D F
Modified contents of al: C+ A+ E+ B+ D+ F+
Modified list backwards: F+ D+ B+ E+ A+ C+
```

How to use a Comparator?

Both TreeSet and TreeMap store elements in sorted order. However, it is the comparator that defines precisely what *sorted order* means.

This interface lets us sort a given collection any number of different ways. Also, this interface can be used to sort any instances of any class(even classes we cannot modify).

SN	Iterator Methods with Description
1	Using Java Comparator Here is a list of all the methods with examples provided by Comparator Interface.

Using Java Comparator

Both TreeSet and TreeMap store elements in sorted order. However, it is the comparator that defines precisely what *sorted order* means.

The Comparator interface defines two methods: compare() and equals(). The compare() method, shown here, compares two elements for order:

The compare Method:

```
int compare(Object obj1, Object obj2)
```

obj1 and obj2 are the objects to be compared. This method returns zero if the objects are equal. It returns a positive value if obj1 is greater than obj2. Otherwise, a negative value is returned.

By overriding compare(), you can alter the way that objects are ordered. For example, to sort in reverse order, you can create a comparator that reverses the outcome of a comparison.

The equals Method:

The equals() method, shown here, tests whether an object equals the invoking comparator:

```
boolean equals(Object obj)
```

obj is the object to be tested for equality. The method returns true if obj and the invoking object are both Comparator objects and use the same ordering. Otherwise, it returns false.

Overriding equals() is unnecessary, and most simple comparators will not do so.

Example:

```
class Dog implements Comparator<Dog>, Comparable<Dog>{
    private String name;
    private int age;
    Dog(){
    }

    Dog(String n, int a){
        name = n;
        age = a;
    }

    public String getDogName(){
        return name;
    }

    public int getDogAge(){
        return age;
    }

    // Overriding the compareTo method
    public int compareTo(Dog d){
        return (this.name).compareTo(d.name);
    }

    // Overriding the compare method to sort the age
    public int compare(Dog d, Dog dl){
        return d.age - dl.age;
    }
}
```

```

public class Example{

    public static void main(String args[]){
        // Takes a list o Dog objects
        List<Dog> list = new ArrayList<Dog>();

        list.add(new Dog("Shaggy",3));
        list.add(new Dog("Lacy",2));
        list.add(new Dog("Roger",10));
        list.add(new Dog("Tommy",4));
        list.add(new Dog("Tammy",1));
        Collections.sort(list);// Sorts the array list

        for(Dog a: list)//printing the sorted list of names
            System.out.print(a.getDogName() + ", ");

        // Sorts the array list using comparator
        Collections.sort(list, new Dog());
        System.out.println(" ");
        for(Dog a: list)//printing the sorted list of ages
            System.out.print(a.getDogName() + " : "+
                a.getDogAge() + ", ");
    }
}

```

This would produce the following result:

```

Lacy, Roger, Shaggy, Tammy, Tommy,
Tammy : 1, Lacy : 2, Shaggy : 3, Tommy : 4, Roger : 10,

```

Note: Sorting of the Arrays class is as the same as the Collections.

Summary:

The Java collections framework gives the programmer access to prepackaged data structures as well as to algorithms for manipulating them.

A collection is an object that can hold references to other objects. The collection interfaces declare the operations that can be performed on each type of collection.

The classes and interfaces of the collections framework are in package java.util.

Java Generics

It would be nice if we could write a single sort method that could sort the elements in an Integer array, a String array or an array of any type that supports ordering.

Java **Generic** methods and generic classes enable programmers to specify, with a single method declaration, a set of related methods or, with a single class declaration, a set of related types, respectively.

Generics also provide compile-time type safety that allows programmers to catch invalid types at compile time.

Using Java Generic concept, we might write a generic method for sorting an array of objects, then invoke the generic method with Integer arrays, Double arrays, String arrays and so on, to sort the array elements.

Generic Methods:

You can write a single generic method declaration that can be called with arguments of different types. Based on the types of the arguments passed to the generic method, the compiler handles each method call appropriately. Following are the rules to define Generic Methods:

- All generic method declarations have a type parameter section delimited by angle brackets (< and >) that precedes the method's return type (< E > in the next example).
- Each type parameter section contains one or more type parameters separated by commas. A type parameter, also known as a type variable, is an identifier that specifies a generic type name.
- The type parameters can be used to declare the return type and act as placeholders for the types of the arguments passed to the generic method, which are known as actual type arguments.
- A generic method's body is declared like that of any other method. Note that type parameters can represent only reference types, not primitive types (like int, double and char).

Example:

Following example illustrates how we can print array of different type using a single Generic method:

```
public class GenericMethodTest
{
    // generic method printArray
    public static< E >void printArray( E[] inputArray )
    {
```

TUTORIALS POINT

Simply Easy Learning

```

// Display array elements
for( E element : inputArray ){
System.out.printf("%s ", element );
}
System.out.println();
}

public static void main(String args[])
{
// Create arrays of Integer, Double and Character
Integer[] intArray ={1,2,3,4,5};
Double[] doubleArray ={1.1,2.2,3.3,4.4};
Character[] charArray ='H','E','L','L','O';

System.out.println("Array integerArray contains:");
printArray( intArray );// pass an Integer array

System.out.println("\nArray doubleArray contains:");
printArray( doubleArray );// pass a Double array

System.out.println("\nArray characterArray contains:");
printArray( charArray );// pass a Character array
}
}

```

This would produce the following result:

```

Array integerArray contains:
123456

Array doubleArray contains:
1.12.23.34.4

Array characterArray contains:
H E L L O

```

Bounded Type Parameters:

There may be times when you'll want to restrict the kinds of types that are allowed to be passed to a type parameter. For example, a method that operates on numbers might only want to accept instances of Number or its subclasses. This is what bounded type parameters are for.

To declare a bounded type parameter, list the type parameter's name, followed by the extends keyword, followed by its upper bound.

Example:

Following example illustrates how extends is used in a general sense to mean either "extends" (as in classes) or "implements" (as in interfaces). This example is Generic method to return the largest of three Comparable objects:

```

public class MaximumTest
{
// determines the largest of three Comparable objects
publicstatic<T extendsComparable<T>> T maximum(T x, T y, T z)
{
T max = x;// assume x is initially the largest
if( y.compareTo( max )>0){
max = y;// y is the largest so far
}
}
}

```

TUTORIALS POINT

Simply Easy Learning

```

if( z.compareTo( max )>0){
max = z;// z is the largest now
}
return max;// returns the largest object
}
public static void main(String args[])
{
System.out.printf("Max of %d, %d and %d is %d\n\n",3,4,5, maximum(3,4,5));

System.out.printf("Maxm of %.1f,%.1f and %.1f is %.1f\n\n",6.6,8.8,7.7,
maximum(6.6,8.8,7.7));

System.out.printf("Max of %s, %s and %s is %s\n","pear",
"apple","orange", maximum("pear","apple","orange"));
}
}

```

This would produce the following result:

```

Maximum of 3,4and5is5

Maximum of 6.6,8.8and7.7is8.8

Maximum of pear, apple and orange is pear

```

Generic Classes:

A generic class declaration looks like a non-generic class declaration, except that the class name is followed by a type parameter section.

As with generic methods, the type parameter section of a generic class can have one or more type parameters separated by commas. These classes are known as parameterized classes or parameterized types because they accept one or more parameters.

Example:

Following example illustrates how we can define a generic class:

```

public class Box<T>{

private T t;

publicvoid add(T t){
this.t = t;
}

public T get(){
return t;
}

public static void main(String[] args){
Box<Integer> integerBox =new Box<Integer>();
Box<String> stringBox =new Box<String>();

integerBox.add(newInteger(10));
stringBox.add(new String("Hello World"));

System.out.printf("Integer Value :%d\n\n", integerBox.get());
System.out.printf("String Value :%s\n", stringBox.get());
}
}

```

TUTORIALS POINT

Simply Easy Learning

```
}  
}
```

This would produce the following result:

```
IntegerValue:10  
StringValue:HelloWorld
```

Java Serialization

Java provides a mechanism, called object serialization where an object can be represented as a sequence of bytes that includes the object's data as well as information about the object's type and the types of data stored in the object.

After a serialized object has been written into a file, it can be read from the file and deserialized that is, the type information and bytes that represent the object and its data can be used to recreate the object in memory.

Most impressive is that the entire process is JVM independent, meaning an object can be serialized on one platform and deserialized on an entirely different platform.

Classes **ObjectInputStream** and **ObjectOutputStream** are high-level streams that contain the methods for serializing and deserializing an object.

The **ObjectOutputStream** class contains many write methods for writing various data types, but one method in particular stands out:

```
public final void writeObject(Object x) throws IOException
```

The above method serializes an **Object** and sends it to the output stream. Similarly, the **ObjectInputStream** class contains the following method for deserializing an object:

```
public final Object readObject() throws IOException,  
ClassNotFoundException
```

This method retrieves the next **Object** out of the stream and deserializes it. The return value is **Object**, so you will need to cast it to its appropriate data type.

To demonstrate how serialization works in Java, I am going to use the **Employee** class that we discussed early on in the book. Suppose that we have the following **Employee** class, which implements the **Serializable** interface:

```
public class Employee implements java.io.Serializable  
{  
    public String name;  
    public String address;  
    public transient int SSN;  
    public int number;  
    public void mailCheck()  
    {  
        System.out.println("Mailing a check to "+ name+" "+ address);  
    }  
}
```

```
}
```

Notice that for a class to be serialized successfully, two conditions must be met:

- The class must implement the `java.io.Serializable` interface.
- All of the fields in the class must be serializable. If a field is not serializable, it must be marked `transient`.

If you are curious to know if a Java Standard Class is serializable or not, check the documentation for the class. The test is simple: If the class implements `java.io.Serializable`, then it is serializable; otherwise, it's not.

Serializing an Object:

The `ObjectOutputStream` class is used to serialize an `Object`. The following `SerializeDemo` program instantiates an `Employee` object and serializes it to a file.

When the program is done executing, a file named `employee.ser` is created. The program does not generate any output, but study the code and try to determine what the program is doing.

Note: When serializing an object to a file, the standard convention in Java is to give the file a `.ser` extension.

```
import java.io.*;

public class SerializeDemo
{
    public static void main(String[] args)
    {
        Employee e =new Employee();
        e.name ="Reyan Ali";
        e.address ="Phokka Kuan, Ambehta Peer";
        e.SSN =11122333;
        e.number =101;
        try
        {
            FileOutputStream fileOut =new FileOutputStream("employee.ser");
            ObjectOutputStream out=new ObjectOutputStream(fileOut);
            out.writeObject(e);
            out.close();
            fileOut.close();
        }catch(IOException i)
        {
            i.printStackTrace();
        }
    }
}
```

Deserializing an Object:

The following `DeserializeDemo` program deserializes the `Employee` object created in the `SerializeDemo` program. Study the program and try to determine its output:

```
import java.io.*;
public class DeserializeDemo
{
    public static void main(String[] args)
    {
        Employee e =null;
    }
}
```

```

try
{
FileInputStream fileIn =new FileInputStream("employee.ser");
ObjectInputStream in=new ObjectInputStream(fileIn);
e =(Employee) in.readObject();
in.close();
fileIn.close();
}catch(IOException i)
{
i.printStackTrace();
return;
}catch(ClassNotFoundException c)
{
System.out.println("Employee class not found");
c.printStackTrace();
return;
}
System.out.println("Deserialized Employee...");
System.out.println("Name: "+ e.name);
System.out.println("Address: "+ e.address);
System.out.println("SSN: "+ e.SSN);
System.out.println("Number: "+ e.number);
}
}

```

This would produce the following result:

```

DeserializedEmployee...
Name:ReyanAli
Address:PhokkaKuan,AmbehtaPeer
SSN:0
Number:101

```

Here are following important points to be noted:

- The try/catch block tries to catch a ClassNotFoundException, which is declared by the readObject() method. For a JVM to be able to deserialize an object, it must be able to find the bytecode for the class. If the JVM can't find a class during the deserialization of an object, it throws a ClassNotFoundException.
- Notice that the return value of readObject() is cast to an Employee reference.
- The value of the SSN field was 11122333 when the object was serialized, but because the field is transient, this value was not sent to the output stream. The SSN field of the deserialized Employee object is 0.

Java Networking

The term *network programming* refers to writing programs that execute across multiple devices (computers), in which the devices are all connected to each other using a network.

The `java.net` package of the J2SE APIs contains a collection of classes and interfaces that provide the low-level communication details, allowing you to write programs that focus on solving the problem at hand.

The `java.net` package provides support for the two common network protocols:

- **TCP:** TCP stands for Transmission Control Protocol, which allows for reliable communication between two applications. TCP is typically used over the Internet Protocol, which is referred to as TCP/IP.
- **UDP:** UDP stands for User Datagram Protocol, a connection-less protocol that allows for packets of data to be transmitted between applications.

This tutorial gives good understanding on the following two subjects:

- **Socket Programming:** This is most widely used concept in Networking and it has been explained in very detail.
- **URL Processing:** This would be covered separately. Click here to learn about [URL Processing](#) in Java language.

Url Processing

URL stands for Uniform Resource Locator and represents a resource on the World Wide Web, such as a Web page or FTP directory.

This section shows you how to write Java programs that communicate with a URL. A URL can be broken down into parts, as follows:

```
protocol://host:port/path?query#ref
```

Examples of protocols include HTTP, HTTPS, FTP, and File. The path is also referred to as the filename, and the host is also called the authority.

The following is a URL to a Web page whose protocol is HTTP:

```
http://www.amrood.com/index.htm?language=en#j2se
```

Notice that this URL does not specify a port, in which case the default port for the protocol is used. With HTTP, the default port is 80.

TUTORIALS POINT

Simply Easy Learning

URL Class Methods:

The **java.net.URL** class represents a URL and has complete set of methods to manipulate URL in Java.

The URL class has several constructors for creating URLs, including the following:

SN	Methods with Description
1	public URL(String protocol, String host, int port, String file) throws MalformedURLException. Creates a URL by putting together the given parts.
2	public URL(String protocol, String host, String file) throws MalformedURLException Identical to the previous constructor, except that the default port for the given protocol is used.
3	public URL(String url) throws MalformedURLException Creates a URL from the given String
4	public URL(URL context, String url) throws MalformedURLException Creates a URL by parsing the together the URL and String arguments

The URL class contains many methods for accessing the various parts of the URL being represented.

Some of the methods in the URL class include the following:

SN	Methods with Description
1	public String getPath() Returns the path of the URL.
2	public String getQuery() Returns the query part of the URL.
3	public String getAuthority() Returns the authority of the URL.
4	public int getPort() Returns the port of the URL.
5	public int getDefaultPort() Returns the default port for the protocol of the URL.
6	public String getProtocol() Returns the protocol of the URL.
7	public String getHost() Returns the host of the URL.
8	public String getHost() Returns the host of the URL.
9	public String getFile() Returns the filename of the URL.
10	public String getRef() Returns the reference part of the URL.
11	public URLConnection openConnection() throws IOException Opens a connection to the URL, allowing a client to communicate with the resource.

Example:

The following URLDemo program demonstrates the various parts of a URL. A URL is entered on the command line, and the URLDemo program outputs each part of the given URL.

```
// File Name : URLDemo.java

import java.net.*;
import java.io.*;

public class URLDemo
{
public static void main(String[] args)
{
try
{
URL url =new URL(args[0]);
System.out.println("URL is "+ url.toString());
System.out.println("protocol is "+ url.getProtocol());
System.out.println("authority is "+ url.getAuthority());
System.out.println("file name is "+ url.getFile());
System.out.println("host is "+ url.getHost());
System.out.println("path is "+ url.getPath());
System.out.println("port is "+ url.getPort());
System.out.println("default port is "+ url.getDefaultPort());
System.out.println("query is "+ url.getQuery());
System.out.println("ref is "+ url.getRef());
}catch(IOException e)
{
e.printStackTrace();
}
}
}
```

A sample run of the thid program would produce the following result:

```
$ java URLDemo http://www.amrood.com/index.htm?language=en#j2se
URL is http://www.amrood.com/index.htm?language=en#j2se
protocol is http
authority is www.amrood.com
file name is/index.htm?language=en
host is www.amrood.com
path is/index.htm
port is-1
default port is80
query is language=en
ref is j2se
```

URLConnections Class Methods:

The openConnection() method returns a **java.net.URLConnection**, an abstract class whose subclasses represent the various types of URL connections.

For example:

- If you connect to a URL whose protocol is HTTP, the openConnection() method returns an HttpURLConnection object.
- If you connect to a URL that represents a JAR file, the openConnection() method returns a JarURLConnection object.

TUTORIALS POINT

Simply Easy Learning

- etc...

The URLConnection class has many methods for setting or determining information about the connection, including the following:

SN	Methods with Description
1	Object getContent() Retrieves the contents of this URL connection.
2	Object getContent(Class[] classes) Retrieves the contents of this URL connection.
3	String getContentEncoding() Returns the value of the content-encoding header field.
4	int getContentLength() Returns the value of the content-length header field.
5	String getContentType() Returns the value of the content-type header field.
6	int getLastModified() Returns the value of the last-modified header field.
7	long getExpiration() Returns the value of the expires header field.
8	long getIfModifiedSince() Returns the value of this object's ifModifiedSince field.
9	public void setDoInput(boolean input) Passes in true to denote that the connection will be used for input. The default value is true because clients typically read from a URLConnection.
10	public void setDoOutput(boolean output) Passes in true to denote that the connection will be used for output. The default value is false because many types of URLs do not support being written to.
11	public InputStream getInputStream() throws IOException Returns the input stream of the URL connection for reading from the resource.
12	public OutputStream getOutputStream() throws IOException Returns the output stream of the URL connection for writing to the resource
13	public URL getURL() Returns the URL that this URLConnection object is connected to

Example:

The following URLConnectionDemo program connects to a URL entered from the command line.

If the URL represents an HTTP resource, the connection is cast to HttpURLConnection, and the data in the resource is read one line at a time.

```
// File Name : URLConnDemo.java
import java.net.*;
import java.io.*;
public class URLConnDemo
```

TUTORIALS POINT

Simply Easy Learning

```

{
public static void main(String[] args)
{
try
{
URL url =new URL(args[0]);
URLConnection urlConnection = url.openConnection();
HttpURLConnection connection =null;
if(urlConnection instanceof HttpURLConnection)
{
connection =(HttpURLConnection) urlConnection;
}
else
{
System.out.println("Please enter an HTTP URL.");
return;
}
BufferedReader in=new BufferedReader(
new InputStreamReader(connection.getInputStream()));
String urlString ="";
String current;
while((current =in.readLine())!=null)
{
urlString += current;
}
System.out.println(urlString);
}catch(IOException e)
{
e.printStackTrace();
}
}
}

```

A sample run of the thid program would produce the following result:

```

$ java URLConnDemo http://www.amrood.com
.....a complete HTML content of home page of amrood.com.....

```

Socket Programming:

Sockets provide the communication mechanism between two computers using TCP. A client program creates a socket on its end of the communication and attempts to connect that socket to a server.

When the connection is made, the server creates a socket object on its end of the communication. The client and server can now communicate by writing to and reading from the socket.

The `java.net.Socket` class represents a socket, and the `java.net.ServerSocket` class provides a mechanism for the server program to listen for clients and establish connections with them.

The following steps occur when establishing a TCP connection between two computers using sockets:

- The server instantiates a `ServerSocket` object, denoting which port number communication is to occur on.
- The server invokes the `accept()` method of the `ServerSocket` class. This method waits until a client connects to the server on the given port.

- After the server is waiting, a client instantiates a Socket object, specifying the server name and port number to connect to.
- The constructor of the Socket class attempts to connect the client to the specified server and port number. If communication is established, the client now has a Socket object capable of communicating with the server.
- On the server side, the accept() method returns a reference to a new socket on the server that is connected to the client's socket.

After the connections are established, communication can occur using I/O streams. Each socket has both an OutputStream and an InputStream. The client's OutputStream is connected to the server's InputStream, and the client's InputStream is connected to the server's OutputStream.

TCP is a twoway communication protocol, so data can be sent across both streams at the same time. There are following usefull classes providing complete set of methods to implement sockets.

ServerSocket Class Methods:

The **java.net.ServerSocket** class is used by server applications to obtain a port and listen for client requests

The ServerSocket class has four constructors:

SN	Methods with Description
1	public ServerSocket(int port) throws IOException Attempts to create a server socket bound to the specified port. An exception occurs if the port is already bound by another application.
2	public ServerSocket(int port, int backlog) throws IOException Similar to the previous constructor, the backlog parameter specifies how many incoming clients to store in a wait queue.
3	public ServerSocket(int port, int backlog, InetAddress address) throws IOException Similar to the previous constructor, the InetAddress parameter specifies the local IP address to bind to. The InetAddress is used for servers that may have multiple IP addresses, allowing the server to specify which of its IP addresses to accept client requests on
4	public ServerSocket() throws IOException Creates an unbound server socket. When using this constructor, use the bind() method when you are ready to bind the server socket

If the ServerSocket constructor does not throw an exception, it means that your application has successfully bound to the specified port and is ready for client requests.

Here are some of the common methods of the ServerSocket class:

SN	Methods with Description
1	public int getLocalPort() Returns the port that the server socket is listening on. This method is useful if you passed in 0 as the port number in a constructor and let the server find a port for you.
2	public Socket accept() throws IOException Waits for an incoming client. This method blocks until either a client connects to the server on the specified port or the socket times out, assuming that the time-out value has been set using the setSoTimeout() method. Otherwise, this method blocks indefinitely.
3	public void setSoTimeout(int timeout) Sets the time-out value for how long the server socket waits for a client during the accept().

4	public void bind(SocketAddress host, int backlog) Binds the socket to the specified server and port in the SocketAddress object. Use this method if you instantiated the ServerSocket using the no-argument constructor.
---	--

When the ServerSocket invokes accept(), the method does not return until a client connects. After a client does connect, the ServerSocket creates a new Socket on an unspecified port and returns a reference to this new Socket. A TCP connection now exists between the client and server, and communication can begin.

Socket Class Methods:

The **java.net.Socket** class represents the socket that both the client and server use to communicate with each other. The client obtains a Socket object by instantiating one, whereas the server obtains a Socket object from the return value of the accept() method.

The Socket class has five constructors that a client uses to connect to a server:

SN	Methods with Description
1	public Socket(String host, int port) throws UnknownHostException, IOException. This method attempts to connect to the specified server at the specified port. If this constructor does not throw an exception, the connection is successful and the client is connected to the server.
2	public Socket(InetAddress host, int port) throws IOException This method is identical to the previous constructor, except that the host is denoted by an InetAddress object.
3	public Socket(String host, int port, InetAddress localAddress, int localPort) throws IOException. Connects to the specified host and port, creating a socket on the local host at the specified address and port.
4	public Socket(InetAddress host, int port, InetAddress localAddress, int localPort) throws IOException. This method is identical to the previous constructor, except that the host is denoted by an InetAddress object instead of a String
5	public Socket() Creates an unconnected socket. Use the connect() method to connect this socket to a server.

When the Socket constructor returns, it does not simply instantiate a Socket object but it actually attempts to connect to the specified server and port.

Some methods of interest in the Socket class are listed here. Notice that both the client and server have a Socket object, so these methods can be invoked by both the client and server.

SN	Methods with Description
1	public void connect(SocketAddress host, int timeout) throws IOException This method connects the socket to the specified host. This method is needed only when you instantiated the Socket using the no-argument constructor.
2	public InetAddress getInetAddress() This method returns the address of the other computer that this socket is connected to.
3	public int getPort() Returns the port the socket is bound to on the remote machine.
4	public int getLocalPort() Returns the port the socket is bound to on the local machine.

5	public SocketAddress getRemoteSocketAddress() Returns the address of the remote socket.
6	public InputStream getInputStream() throws IOException Returns the input stream of the socket. The input stream is connected to the output stream of the remote socket.
7	public OutputStream getOutputStream() throws IOException Returns the output stream of the socket. The output stream is connected to the input stream of the remote socket
8	public void close() throws IOException Closes the socket, which makes this Socket object no longer capable of connecting again to any server

InetAddress Class Methods:

This class represents an Internet Protocol (IP) address. Here are following useful methods, which you would need while doing socket programming:

SN	Methods with Description
1	static InetAddress getByAddress(byte[] addr) Returns an InetAddress object given the raw IP address .
2	static InetAddress getByAddress(String host, byte[] addr) Create an InetAddress based on the provided host name and IP address.
3	static InetAddress getByName(String host) Determines the IP address of a host, given the host's name.
4	String getHostAddress() Returns the IP address string in textual presentation.
5	String getHostName() Gets the host name for this IP address.
6	static InetAddress InetAddress getLocalHost() Returns the local host.
7	String toString() Converts this IP address to a String.

Socket Client Example:

The following GreetingClient is a client program that connects to a server by using a socket and sends a greeting, and then waits for a response.

```
// File Name GreetingClient.java

import java.net.*;
import java.io.*;

public class GreetingClient
{
    public static void main(String[] args)
    {
        String serverName = args[0];
        int port =Integer.parseInt(args[1]);
        try
```

```

{
System.out.println("Connecting to "+ serverName+" on port "+ port);
Socket client =new Socket(serverName, port);
System.out.println("Just connected to "+ client.getRemoteSocketAddress());
OutputStream outToServer = client.getOutputStream();
DataOutputStream out=new DataOutputStream(outToServer);

out.writeUTF("Hello from "+ client.getLocalSocketAddress());
InputStream inFromServer = client.getInputStream();
DataInputStream in=new DataInputStream(inFromServer);
System.out.println("Server says "+in.readUTF());
    client.close();
}catch(IOException e)
{
    e.printStackTrace();
}
}
}

```

Socket Server Example:

The following GreetingServer program is an example of a server application that uses the Socket class to listen for clients on a port number specified by a command-line argument:

```

// File Name GreetingServer.java

import java.net.*;
import java.io.*;

public class GreetingServer extends Thread
{
private ServerSocket serverSocket;

public GreetingServer(int port)throws IOException
{
serverSocket =new ServerSocket(port);
    serverSocket.setSoTimeout(10000);
}

public void run()
{
while(true)
{
try
{
System.out.println("Waiting for client on port "+
serverSocket.getLocalPort()+"...");
Socket server = serverSocket.accept();
System.out.println("Just connected to "
+ server.getRemoteSocketAddress());
DataInputStream in=new DataInputStream(server.getInputStream());
System.out.println(in.readUTF());
DataOutputStream out=new DataOutputStream(server.getOutputStream());
out.writeUTF("Thank you for connecting to "+
server.getLocalSocketAddress()+"\nGoodbye!");
server.close();
}catch(SocketTimeoutException s)
{
System.out.println("Socket timed out!");
}
}
}
}

```

TUTORIALS POINT

Simply Easy Learning

```
break;
} catch (IOException e)
{
    e.printStackTrace();
break;
}
}
}
public static void main(String[] args)
{
    int port =Integer.parseInt(args[0]);
    try
    {
        Thread t =new GreetingServer(port);
        t.start();
    } catch (IOException e)
    {
        e.printStackTrace();
    }
}
}
```

Compile client and server and then start server as follows:

```
$ java GreetingServer6066
Waitingfor client on port 6066...
```

Check client program as follows:

```
$ java GreetingClient localhost 6066
Connecting to localhost on port 6066
Just connected to localhost/127.0.0.1:6066
Server says Thank you for connecting to /127.0.0.1:6066
Goodbye!
```

Java Sending E-mail

To send an e-mail using your Java Application is simple enough but to start with you should have **JavaMail**

API and **Java Activation Framework (JAF)** installed on your machine.

- You can download latest version of [JavaMail \(Version 1.2\)](#) from Java's standard website.
- You can download latest version of [JAF \(Version 1.1.1\)](#) from Java's standard website.

Download and unzip these files, in the newly created top level directories you will find a number of jar files for both the applications. You need to add **mail.jar** and **activation.jar** files in your CLASSPATH.

Send a Simple E-mail:

Here is an example to send a simple e-mail from your machine. Here it is assumed that your **localhost** is connected to the internet and capable enough to send an e-mail.

```
// File Name SendEmail.java

import java.util.*;
import javax.mail.*;
import javax.mail.internet.*;
import javax.activation.*;

public class SendEmail
{
    public static void main(String[] args)
    {
        // Recipient's email ID needs to be mentioned.
        String to = "abcd@gmail.com";

        // Sender's email ID needs to be mentioned
        String from = "web@gmail.com";

        // Assuming you are sending email from localhost
        String host = "localhost";

        // Get system properties
        Properties properties = System.getProperties();

        // Setup mail server
        properties.setProperty("mail.smtp.host", host);

        // Get the default Session object.
```

TUTORIALS POINT

Simply Easy Learning

```

Session session =Session.getDefaultInstance(properties);

try{
// Create a default MimeMessage object.
MimeMessage message =new MimeMessage(session);

// Set From: header field of the header.
message.setFrom(new InternetAddress(from));

// Set To: header field of the header.
message.addRecipient(Message.RecipientType.TO,new InternetAddress(to));

// Set Subject: header field
message.setSubject("This is the Subject Line!");

// Now set the actual message
message.setText("This is actual message");

// Send message
Transport.send(message);
System.out.println("Sent message successfully...");
}catch(MessagingException mex){
mex.printStackTrace();
}
}
}

```

Compile and run this program to send a simple e-mail:

```

$ java SendEmail
Sent message successfully...

```

If you want to send an e-mail to multiple recipients, then following methods would be used to specify multiple e-mail IDs:

```

void addRecipients(Message.RecipientType type,
Address[] addresses)
throwsMessagingException

```

Here is the description of the parameters:

- **type:** This would be set to TO, CC or BCC. Here CC represents Carbon Copy and BCC represents Black Carbon Copy. Example *Message.RecipientType.TO*
- **addresses:** This is the array of e-mail ID. You would need to use *InternetAddress()* method while specifying e-mail IDs

Send an HTML E-mail:

Here is an example to send an HTML e-mail from your machine. Here, it is assumed that your **localhost** is connected to the internet and capable enough to send an e-mail.

This example is very similar to previous one, except here we are using *setContent()* method to set content, whose second argument is "text/html" to specify that the HTML content is included in the message.

Using this example, you can send as big as HTML content you like.

```

// File Name SendHTMLEmail.java

import java.util.*;
import javax.mail.*;

```

```

import javax.mail.internet.*;
import javax.activation.*;

public class SendHTMLEmail
{
public static void main(String[] args)
{

// Recipient's email ID needs to be mentioned.
String to ="abcd@gmail.com";

// Sender's email ID needs to be mentioned
Stringfrom="web@gmail.com";

// Assuming you are sending email from localhost
String host ="localhost";

// Get system properties
Properties properties =System.getProperties();

// Setup mail server
properties.setProperty("mail.smtp.host", host);

// Get the default Session object.
Session session =Session.getDefaultInstance(properties);

try{
// Create a default MimeMessage object.
MimeMessage message =new MimeMessage(session);

// Set From: header field of the header.
message.setFrom(new InternetAddress(from));

// Set To: header field of the header.
message.addRecipient(Message.RecipientType.TO,
newInternetAddress(to));

// Set Subject: header field
message.setSubject("This is the Subject Line!");

// Send the actual HTML message, as big as you like
message.setContent("<h1>This is actual message</h1>",
"text/html");

// Send message
Transport.send(message);
System.out.println("Sent message successfully...");
}catch(MessagingException mex){
    mex.printStackTrace();
}
}
}

```

Compile and run this program to send an HTML e-mail:

```

$ java SendHTMLEmail
Sent message successfully...

```

Send Attachment in E-mail:

Here is an example to send an e-mail with attachment from your machine. Here, it is assumed that your **localhost** is connected to the internet and capable enough to send an e-mail.

```
// File Name SendFileEmail.java

import java.util.*;
import javax.mail.*;
import javax.mail.internet.*;
import javax.activation.*;

public class SendFileEmail
{
    public static void main(String[] args)
    {

        // Recipient's email ID needs to be mentioned.
        String to ="abcd@gmail.com";

        // Sender's email ID needs to be mentioned
        Stringfrom="web@gmail.com";

        // Assuming you are sending email from localhost
        String host ="localhost";

        // Get system properties
        Properties properties =System.getProperties();

        // Setup mail server
        properties.setProperty("mail.smtp.host", host);

        // Get the default Session object.
        Session session =Session.getDefaultInstance(properties);

        try{
            // Create a default MimeMessage object.
            MimeMessage message =new MimeMessage(session);

            // Set From: header field of the header.
            message.setFrom(new InternetAddress(from));

            // Set To: header field of the header.
            message.addRecipient(Message.RecipientType.TO,
            new InternetAddress(to));

            // Set Subject: header field
            message.setSubject("This is the Subject Line!");

            // Create the message part
            BodyPart messageBodyPart =new MimeBodyPart();

            // Fill the message
            messageBodyPart.setText("This is message body");

            // Create a multipart message
            Multipart multipart =new MimeMultipart();

            // Set text message part
            multipart.addBodyPart(messageBodyPart);
```

```
// Part two is attachment
messageBodyPart =new MimeBodyPart();
String filename ="file.txt";
DataSource source =new FileDataSource(filename);
messageBodyPart.setDataHandler(new DataHandler(source));
messageBodyPart.setFileName(filename);
multipart.addBodyPart(messageBodyPart);

// Send the complete message parts
message.setContent(multipart );

// Send message
Transport.send(message);
System.out.println("Sent message successfully...");
}catch (MessagingException mex) {
mex.printStackTrace();
}
}
}
```

Compile and run this program to send an HTML e-mail:

```
$ java SendFileEmail
Sent message successfully...
```

User Authentication Part:

If it is required to provide user ID and Password to the e-mail server for authentication purpose, then you can set these properties as follows:

```
props.setProperty("mail.user", "myuser");
props.setProperty("mail.password", "mypwd");
```

Rest of the e-mail sending mechanism would remain as explained above.

Java Multithreading

Java is a *multithreaded programming language* which means we can develop multithreaded program using

Java. A multithreaded program contains two or more parts that can run concurrently and each part can handle different task at the same time making optimal use of the available resources specially when your computer has multiple CPUs.

By definition multitasking is when multiple processes share common processing resources such as a CPU. Multithreading extends the idea of multitasking into applications where you can subdivide specific operations within a single application into individual threads. Each of the threads can run in parallel. The OS divides processing time not only among different applications, but also among each thread within an application.

Multithreading enables you to write in a way where multiple activities can proceed concurrently in the same program.

Life Cycle of a Thread:

A thread goes through various stages in its life cycle. For example, a thread is born, started, runs, and then dies. Following diagram shows complete life cycle of a thread.

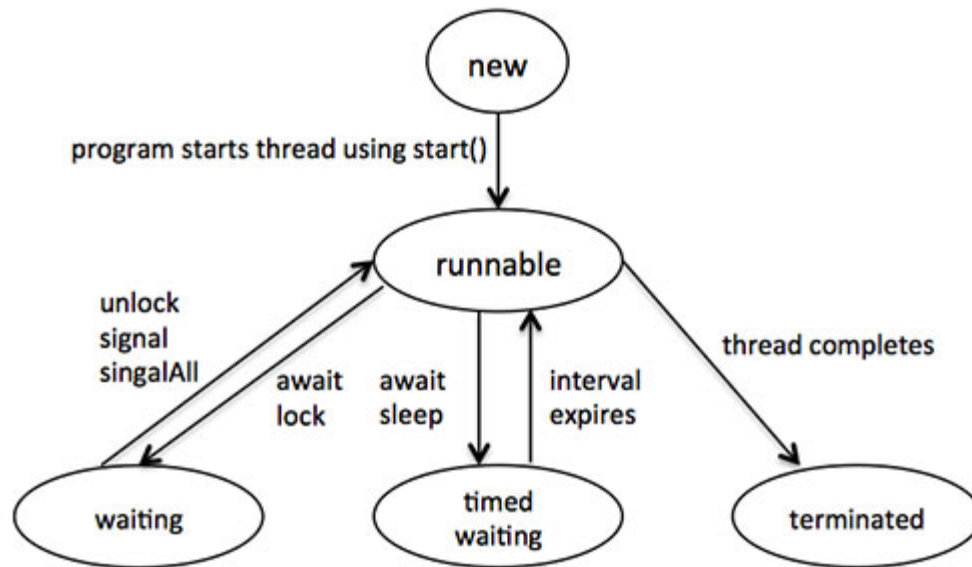

Above-mentioned stages are explained here:

- **New:** A new thread begins its life cycle in the new state. It remains in this state until the program starts the thread. It is also referred to as a born thread.
- **Runnable:** After a newly born thread is started, the thread becomes runnable. A thread in this state is considered to be executing its task.
- **Waiting:** Sometimes, a thread transitions to the waiting state while the thread waits for another thread to perform a task. A thread transitions back to the runnable state only when another thread signals the waiting thread to continue executing.
- **Timed waiting:** A runnable thread can enter the timed waiting state for a specified interval of time. A thread in this state transitions back to the runnable state when that time interval expires or when the event it is waiting for occurs.
- **Terminated:** A runnable thread enters the terminated state when it completes its task or otherwise terminates.

Thread Priorities:

Every Java thread has a priority that helps the operating system determine the order in which threads are scheduled.

Java thread priorities are in the range between MIN_PRIORITY (a constant of 1) and MAX_PRIORITY (a constant of 10). By default, every thread is given priority NORM_PRIORITY (a constant of 5).

Threads with higher priority are more important to a program and should be allocated processor time before lower-priority threads. However, thread priorities cannot guarantee the order in which threads execute and very much platform dependent.

Create Thread by Implementing Runnable Interface:

If your class is intended to be executed as a thread then you can achieve this by implementing **Runnable** interface. You will need to follow three basic steps:

STEP 1:

As a first step you need to implement a `run()` method provided by `Runnable` interface. This method provides entry point for the thread and you will put your complete business logic inside this method. Following is simple syntax of `run()` method:

```
public void run( )
```

STEP 2:

At second step you will instantiate a **Thread** object using the following constructor:

```
Thread(Runnable threadObj, String threadName);
```

Where, *threadObj* is an instance of a class that implements the **Runnable** interface and **threadName** is the name given to the new thread.

STEP 3

Once Thread object is created, you can start it by calling `start()` method, which executes a call to `run()` method. Following is simple syntax of `start()` method:

```
void start( );
```

Example:

Here is an example that creates a new thread and starts it running:

```
class RunnableDemo implements Runnable {
    private Thread t;
    private String threadName;

    RunnableDemo( String name){
        threadName = name;
        System.out.println("Creating " + threadName );
    }
    public void run() {
        System.out.println("Running " + threadName );
        try {
            for(int i = 4; i > 0; i--) {
                System.out.println("Thread: " + threadName + ", " + i);
                // Let the thread sleep for a while.
                Thread.sleep(50);
            }
        } catch (InterruptedException e) {
            System.out.println("Thread " + threadName + " interrupted.");
        }
        System.out.println("Thread " + threadName + " exiting.");
    }

    public void start ()
    {
        System.out.println("Starting " + threadName );
        if (t == null)
        {
            t = new Thread (this, threadName);
            t.start ();
        }
    }
}
```

TUTORIALS POINT

Simply Easy Learning

```

    }
}

public class TestThread {
    public static void main(String args[]) {

        RunnableDemo R1 = new RunnableDemo( "Thread-1");
        R1.start();

        RunnableDemo R2 = new RunnableDemo( "Thread-2");
        R2.start();

    }
}

```

This would produce the following result:

```

Creating Thread-1
Starting Thread-1
Creating Thread-2
Starting Thread-2
Running Thread-1
Thread: Thread-1, 4
Running Thread-2
Thread: Thread-2, 4
Thread: Thread-1, 3
Thread: Thread-2, 3
Thread: Thread-1, 2
Thread: Thread-2, 2
Thread: Thread-1, 1
Thread: Thread-2, 1
Thread Thread-1 exiting.
Thread Thread-2 exiting.

```

Create Thread by Extending Thread Class:

The second way to create a thread is to create a new class that extends **Thread** class using the following two simple steps. This approach provides more flexibility in handling multiple threads created using available methods in Thread class.

STEP 1

You will need to override **run()** method available in Thread class. This method provides entry point for the thread and you will put your complete business logic inside this method. Following is simple syntax of **run()** method:

```
public void run( )
```

STEP 2

Once Thread object is created, you can start it by calling **start()** method, which executes a call to **run()** method. Following is simple syntax of **start()** method:

```
void start( );
```

Example:

Here is the preceding program rewritten to extend Thread:

```

class ThreadDemo extends Thread {
    private Thread t;
    private String threadName;

    ThreadDemo( String name){
        threadName = name;
        System.out.println("Creating " + threadName );
    }
    public void run() {
        System.out.println("Running " + threadName );
        try {
            for(int i = 4; i > 0; i--) {
                System.out.println("Thread: " + threadName + ", " + i);
                // Let the thread sleep for a while.
                Thread.sleep(50);
            }
        } catch (InterruptedException e) {
            System.out.println("Thread " + threadName + " interrupted.");
        }
        System.out.println("Thread " + threadName + " exiting.");
    }

    public void start ()
    {
        System.out.println("Starting " + threadName );
        if (t == null)
        {
            t = new Thread (this, threadName);
            t.start ();
        }
    }
}

public class TestThread {
    public static void main(String args[]) {

        ThreadDemo T1 = new ThreadDemo( "Thread-1");
        T1.start();

        ThreadDemo T2 = new ThreadDemo( "Thread-2");
        T2.start();

    }
}

```

This would produce the following result:

```

Creating Thread-1
Starting Thread-1
Creating Thread-2
Starting Thread-2
Running Thread-1
Thread: Thread-1, 4
Running Thread-2
Thread: Thread-2, 4
Thread: Thread-1, 3
Thread: Thread-2, 3
Thread: Thread-1, 2
Thread: Thread-2, 2
Thread: Thread-1, 1
Thread: Thread-2, 1

```

TUTORIALS POINT
Simply Easy Learning

```
Thread Thread-1 exiting.  
Thread Thread-2 exiting.
```

Thread Methods:

Following is the list of important methods available in the Thread class.

SN	Methods with Description
1	public void start() Starts the thread in a separate path of execution, then invokes the run() method on this Thread object.
2	public void run() If this Thread object was instantiated using a separate Runnable target, the run() method is invoked on that Runnable object.
3	public final void setName(String name) Changes the name of the Thread object. There is also a getName() method for retrieving the name.
4	public final void setPriority(int priority) Sets the priority of this Thread object. The possible values are between 1 and 10.
5	public final void setDaemon(boolean on) A parameter of true denotes this Thread as a daemon thread.
6	public final void join(long millisec) The current thread invokes this method on a second thread, causing the current thread to block until the second thread terminates or the specified number of milliseconds passes.
7	public void interrupt() Interrupts this thread, causing it to continue execution if it was blocked for any reason.
8	public final boolean isAlive() Returns true if the thread is alive, which is any time after the thread has been started but before it runs to completion.

The previous methods are invoked on a particular Thread object. The following methods in the Thread class are static. Invoking one of the static methods performs the operation on the currently running thread.

SN	Methods with Description
1	public static void yield() Causes the currently running thread to yield to any other threads of the same priority that are waiting to be scheduled.
2	public static void sleep(long millisec) Causes the currently running thread to block for at least the specified number of milliseconds.
3	public static boolean holdsLock(Object x) Returns true if the current thread holds the lock on the given Object.
4	public static Thread currentThread() Returns a reference to the currently running thread, which is the thread that invokes this method.
5	public static void dumpStack() Prints the stack trace for the currently running thread, which is useful when debugging a multithreaded application.

Example:

The following ThreadClassDemo program demonstrates some of these methods of the Thread class. Consider a class **DisplayMessage** which implements **Runnable**:

```
// File Name : DisplayMessage.java
// Create a thread to implement Runnable
public class DisplayMessage implements Runnable
{
    private String message;
    public DisplayMessage(String message)
    {
        this.message = message;
    }
    public void run()
    {
        while(true)
        {
            System.out.println(message);
        }
    }
}
```

Following is another class which extends Thread class:

```
// File Name : GuessANumber.java
// Create a thread to extend Thread
public class GuessANumber extends Thread
{
    private int number;
    public GuessANumber(int number)
    {
        this.number = number;
    }
    public void run()
    {
        int counter = 0;
        int guess = 0;
        do
        {
            guess = (int) (Math.random() * 100 + 1);
            System.out.println(this.getName()
                + " guesses " + guess);
            counter++;
        }while(guess != number);
        System.out.println("** Correct! " + this.getName()
            + " in " + counter + " guesses.**");
    }
}
```

Following is the main program which makes use of above defined classes:

```
// File Name : ThreadClassDemo.java
public class ThreadClassDemo
{
    public static void main(String [] args)
    {
        Runnable hello = new DisplayMessage("Hello");
        Thread thread1 = new Thread(hello);
        thread1.setDaemon(true);
    }
}
```

TUTORIALS POINT

Simply Easy Learning

```
thread1.setName("hello");
System.out.println("Starting hello thread...");
thread1.start();

Runnable bye = new DisplayMessage("Goodbye");
Thread thread2 = new Thread(bye);
thread2.setPriority(Thread.MIN_PRIORITY);
thread2.setDaemon(true);
System.out.println("Starting goodbye thread...");
thread2.start();

System.out.println("Starting thread3...");
Thread thread3 = new GuessANumber(27);
thread3.start();
try
{
    thread3.join();
} catch (InterruptedException e)
{
    System.out.println("Thread interrupted.");
}
System.out.println("Starting thread4...");
Thread thread4 = new GuessANumber(75);

    thread4.start();
System.out.println("main() is ending...");
}
}
```

This would produce the following result. You can try this example again and again and you would get different result every time.

```
Starting hello thread...
Starting goodbye thread...
Hello
Hello
Hello
Hello
Hello
Hello
Goodbye
Goodbye
Goodbye
Goodbye
Goodbye
.....
```

Major Java Multithreading Concepts:

While doing Multithreading programming in Java, you would need to have the following concepts very handy:

- [What is thread synchronization?](#)
- [Handling threads inter communication](#)
- [Handling thread deadlock](#)
- [Major thread operations](#)

What is Thread synchronization?

When we start two or more threads within a program, there may be a situation when multiple threads try to access the same resource and finally they can produce unforeseen result due to concurrency issue. For example if multiple threads try to write within a same file then they may corrupt the data because one of the threads can overwrite data or while one thread is opening the same file at the same time another thread might be closing the same file.

So there is a need to synchronize the action of multiple threads and make sure that only one thread can access the resource at a given point in time. This is implemented using a concept called **monitors**. Each object in Java is associated with a monitor, which a thread can lock or unlock. Only one thread at a time may hold a lock on a monitor.

Java programming language provides a very handy way of creating threads and synchronizing their task by using **synchronized** blocks. You keep shared resources within this block. Following is the general form of the synchronized statement:

```
synchronized(objectidentifier) {  
    // Access shared variables and other shared resources  
}
```

Here, the **objectidentifier** is a reference to an object whose lock associates with the monitor that the synchronized statement represents. Now we are going to see two examples where we will print a counter using two different threads. When threads are not synchronized, they print counter value which is not in sequence, but when we print counter by putting inside synchronized() block, then it prints counter very much in sequence for both the threads.

Multithreading example without Synchronization:

Here is a simple example which may or may not print counter value in sequence and every time we run it, it produces different result based on CPU availability to a thread.

```
class PrintDemo {  
    public void printCount(){  
        try {  
            for(int i = 5; i > 0; i--) {  
                System.out.println("Counter   ---   " + i );  
            }  
        } catch (Exception e) {  
            System.out.println("Thread   interrupted.");  
        }  
    }  
}  
  
class ThreadDemo extends Thread {  
    private Thread t;  
    private String threadName;  
    PrintDemo PD;  
  
    ThreadDemo( String name, PrintDemo pd){  
        threadName = name;  
        PD = pd;  
    }  
    public void run() {  
        PD.printCount();  
        System.out.println("Thread " + threadName + " exiting.");  
    }  
  
    public void start ()  
    {
```

```

        System.out.println("Starting " + threadName );
        if (t == null)
        {
            t = new Thread (this, threadName);
            t.start ();
        }
    }
}

public class TestThread {
    public static void main(String args[] ) {

        PrintDemo PD = new PrintDemo ();

        ThreadDemo T1 = new ThreadDemo( "Thread - 1 ", PD );
        ThreadDemo T2 = new ThreadDemo( "Thread - 2 ", PD );

        T1.start ();
        T2.start ();

        // wait for threads to end
        try {
            T1.join();
            T2.join();
        } catch( Exception e) {
            System.out.println("Interrupted");
        }
    }
}

```

This produces different result every time you run this program:

```

Starting Thread - 1
Starting Thread - 2
Counter --- 5
Counter --- 4
Counter --- 3
Counter --- 5
Counter --- 2
Counter --- 1
Counter --- 4
Thread Thread - 1 exiting.
Counter --- 3
Counter --- 2
Counter --- 1
Thread Thread - 2 exiting.

```

Multithreading example with Synchronization:

Here is the same example which prints counter value in sequence and every time we run it, it produces same result.

```

class PrintDemo {
    public void printCount(){
        try {
            for(int i = 5; i > 0; i--) {
                System.out.println("Counter --- " + i );
            }
        } catch (Exception e) {
            System.out.println("Thread interrupted.");
        }
    }
}

```



```

    }
}

class ThreadDemo extends Thread {
    private Thread t;
    private String threadName;
    PrintDemo PD;

    ThreadDemo( String name, PrintDemo pd){
        threadName = name;
        PD = pd;
    }
    public void run() {
        synchronized(PD) {
            PD.printCount();
        }
        System.out.println("Thread " + threadName + " exiting.");
    }

    public void start ()
    {
        System.out.println("Starting " + threadName );
        if (t == null)
        {
            t = new Thread (this, threadName);
            t.start ();
        }
    }
}

public class TestThread {
    public static void main(String args[]) {

        PrintDemo PD = new PrintDemo();

        ThreadDemo T1 = new ThreadDemo( "Thread - 1 ", PD );
        ThreadDemo T2 = new ThreadDemo( "Thread - 2 ", PD );

        T1.start();
        T2.start();

        // wait for threads to end
        try {
            T1.join();
            T2.join();
        } catch( Exception e) {
            System.out.println("Interrupted");
        }
    }
}

```

This produces same result every time you run this program:

```

Starting Thread - 1
Starting Thread - 2
Counter --- 5
Counter --- 4
Counter --- 3

```

TUTORIALS POINT
Simply Easy Learning

```

Counter   ---  2
Counter   ---  1
Thread Thread - 1  exiting.
Counter   ---  5
Counter   ---  4
Counter   ---  3
Counter   ---  2
Counter   ---  1
Thread Thread - 2  exiting.

```

Handling threads inter communication

If you are aware of interprocess communication then it will be easy for you to understand inter thread communication. Inter thread communication is important when you develop an application where two or more threads exchange some information.

There are simply three methods and a little trick which makes thread communication possible. First let's see all the three methods listed below:

SN	Methods with Description
1	public void wait() Causes the current thread to wait until another thread invokes the notify().
2	public void notify() Wakes up a single thread that is waiting on this object's monitor.
3	public void notifyAll() Wakes up all the threads that called wait() on the same object.

These methods have been implemented as **final** methods in Object, so they are available in all the classes. All three methods can be called only from within a **synchronized** context.

Example:

This examples shows how two thread can communicate using **wait()** and **notify()** method. You can create a complex system using the same concept.

```

class Chat {
    boolean flag = false;

    public synchronized void Question(String msg) {
        if (flag) {
            try {
                wait();
            } catch (InterruptedException e) {
                e.printStackTrace();
            }
        }
        System.out.println(msg);
        flag = true;
        notify();
    }

    public synchronized void Answer(String msg) {
        if (!flag) {
            try {
                wait();
            }

```

```

        } catch (InterruptedException e) {
            e.printStackTrace();
        }
    }

    System.out.println(msg);
    flag = false;
    notify();
}
}

class T1 implements Runnable {
    Chat m;
    String[] s1 = { "Hi", "How are you ?", "I am also doing fine!" };

    public T1(Chat m1) {
        this.m = m1;
        new Thread(this, "Question").start();
    }

    public void run() {
        for (int i = 0; i < s1.length; i++) {
            m.Question(s1[i]);
        }
    }
}

class T2 implements Runnable {
    Chat m;
    String[] s2 = { "Hi", "I am good, what about you?", "Great!" };

    public T2(Chat m2) {
        this.m = m2;
        new Thread(this, "Answer").start();
    }

    public void run() {
        for (int i = 0; i < s2.length; i++) {
            m.Answer(s2[i]);
        }
    }
}

public class TestThread {
    public static void main(String[] args) {
        Chat m = new Chat();
        new T1(m);
        new T2(m);
    }
}
}

```

When above program is compiled and executed, it produces following result:

```

Hi
Hi
How are you ?
I am good, what about you?
I am also doing fine!
Great!

```

Above example has been taken and then modified from [<http://stackoverflow.com/questions/2170520/inter-thread-communication-in-java>]

Handling threads deadlock

Deadlock describes a situation where two or more threads are blocked forever, waiting for each other. Deadlock occurs when multiple threads need the same locks but obtain them in different order. A Java multithreaded program may suffer from the deadlock condition because the **synchronized** keyword causes the executing thread to block while waiting for the lock, or monitor, associated with the specified object. Here is an example:

Example:

```
public class TestThread {
    public static Object Lock1 = new Object();
    public static Object Lock2 = new Object();

    public static void main(String args[]) {

        ThreadDemo1 T1 = new ThreadDemo1();
        ThreadDemo2 T2 = new ThreadDemo2();
        T1.start();
        T2.start();
    }

    private static class ThreadDemo1 extends Thread {
        public void run() {
            synchronized (Lock1) {
                System.out.println("Thread 1: Holding lock 1...");
                try { Thread.sleep(10); }
                catch (InterruptedException e) {}
                System.out.println("Thread 1: Waiting for lock 2...");
                synchronized (Lock2) {
                    System.out.println("Thread 1: Holding lock 1 & 2...");
                }
            }
        }
    }

    private static class ThreadDemo2 extends Thread {
        public void run() {
            synchronized (Lock2) {
                System.out.println("Thread 2: Holding lock 2...");
                try { Thread.sleep(10); }
                catch (InterruptedException e) {}
                System.out.println("Thread 2: Waiting for lock 1...");
                synchronized (Lock1) {
                    System.out.println("Thread 2: Holding lock 1 & 2...");
                }
            }
        }
    }
}
```

When you compile and execute above program, you find a deadlock situation and below is the output produced by the program:

```
Thread 1: Holding lock 1...
Thread 2: Holding lock 2...
Thread 1: Waiting for lock 2...
Thread 2: Waiting for lock 1...
```

Above program will hang forever because neither of the threads in position to proceed and waiting for each other to release the lock, so you can come out of the program by pressing CTRL-C.

Deadlock Solution Example:

Let's change the order of the lock and run the same program to see if still both the threads waits for each other:

```
public class TestThread {
    public static Object Lock1 = new Object();
    public static Object Lock2 = new Object();

    public static void main(String args[]) {

        ThreadDemo1 T1 = new ThreadDemo1();
        ThreadDemo2 T2 = new ThreadDemo2();
        T1.start();
        T2.start();
    }

    private static class ThreadDemo1 extends Thread {
        public void run() {
            synchronized (Lock1) {
                System.out.println("Thread 1: Holding lock 1...");
                try { Thread.sleep(10); }
                catch (InterruptedException e) {}
                System.out.println("Thread 1: Waiting for lock 2...");
                synchronized (Lock2) {
                    System.out.println("Thread 1: Holding lock 1 & 2...");
                }
            }
        }
    }

    private static class ThreadDemo2 extends Thread {
        public void run() {
            synchronized (Lock1) {
                System.out.println("Thread 2: Holding lock 1...");
                try { Thread.sleep(10); }
                catch (InterruptedException e) {}
                System.out.println("Thread 2: Waiting for lock 2...");
                synchronized (Lock2) {
                    System.out.println("Thread 2: Holding lock 1 & 2...");
                }
            }
        }
    }
}
```

So just changing the order of the locks prevent the program in going deadlock situation and completes with the following result:

```
Thread 1: Holding lock 1...
Thread 1: Waiting for lock 2...
Thread 1: Holding lock 1 & 2...
Thread 2: Holding lock 1...
Thread 2: Waiting for lock 2...
Thread 2: Holding lock 1 & 2...
```

Above example has been shown just for making you the concept clear, but its a more complex concept and you should deep dive into it before you develop your applications to deal with deadlock situations.

Major thread operatios

Core Java provides a complete control over multithreaded program. You can develop a multithreaded program which can be suspended, resumed or stopped completely based on your requirements. There are various static methods which you can use on thread objects to control their behavior. Following table lists down those methods:

SN	Methods with Description
1	public void suspend() This method puts a thread in suspended state and can be resumed using resume() method.
2	public void stop() This method stops a thread completely.
3	public void resume() This method resumes a thread which was suspended using suspend() method.
4	public void wait() Causes the current thread to wait until another thread invokes the notify().
5	public void notify() Wakes up a single thread that is waiting on this object's monitor.

Be aware that latest versions of Java has deprecated the usage of suspend(), resume(), and stop() methods and so you need to use available alternatives.

Example:

```
class RunnableDemo implements Runnable {
    public Thread t;
    private String threadName;
    boolean suspended = false;

    RunnableDemo( String name){
        threadName = name;
        System.out.println("Creating " + threadName );
    }

    public void run() {
        System.out.println("Running " + threadName );
        try {
            for(int i = 10; i > 0; i--) {
                System.out.println("Thread: " + threadName + ", " + i);
                // Let the thread sleep for a while.
                Thread.sleep(300);
                synchronized(this) {
                    while(suspended) {
                        wait();
                    }
                }
            }
        } catch (InterruptedException e) {
            System.out.println("Thread " + threadName + " interrupted.");
        }
        System.out.println("Thread " + threadName + " exiting.");
    }

    public void start ()
    {
        System.out.println("Starting " + threadName );
    }
}
```

```

        if (t == null)
        {
            t = new Thread (this, threadName);
            t.start ();
        }
    }
    void suspend() {
        suspended = true;
    }
    synchronized void resume() {
        suspended = false;
        notify();
    }
}

public class TestThread {
    public static void main(String args[]) {

        RunnableDemo R1 = new RunnableDemo( "Thread-1");
        R1.start();

        RunnableDemo R2 = new RunnableDemo( "Thread-2");
        R2.start();

        try {
            Thread.sleep(1000);
            R1.suspend();
            System.out.println("Suspending First Thread");
            Thread.sleep(1000);
            R1.resume();
            System.out.println("Resuming First Thread");
            R2.suspend();
            System.out.println("Suspending thread Two");
            Thread.sleep(1000);
            R2.resume();
            System.out.println("Resuming thread Two");
        } catch (InterruptedException e) {
            System.out.println("Main thread Interrupted");
        }
        try {
            System.out.println("Waiting for threads to finish.");
            R1.t.join();
            R2.t.join();
        } catch (InterruptedException e) {
            System.out.println("Main thread Interrupted");
        }
        System.out.println("Main thread exiting.");
    }
}

```

Here is the output produced by the above program:

```

Creating Thread-1
Starting Thread-1
Creating Thread-2
Starting Thread-2
Running Thread-1
Thread: Thread-1, 10
Running Thread-2
Thread: Thread-2, 10
Thread: Thread-1, 9

```

```
Thread: Thread-2, 9
Thread: Thread-1, 8
Thread: Thread-2, 8
Thread: Thread-1, 7
Thread: Thread-2, 7
Suspending First Thread
Thread: Thread-2, 6
Thread: Thread-2, 5
Thread: Thread-2, 4
Resuming First Thread
Suspending thread Two
Thread: Thread-1, 6
Thread: Thread-1, 5
Thread: Thread-1, 4
Thread: Thread-1, 3
Resuming thread Two
Thread: Thread-2, 3
Waiting for threads to finish.
Thread: Thread-1, 2
Thread: Thread-2, 2
Thread: Thread-1, 1
Thread: Thread-2, 1
Thread Thread-1 exiting.
Thread Thread-2 exiting.
Main thread exiting.
```

Java Applet Basics

An applet is a Java program that runs in a Web browser. An applet can be a fully functional Java application because it has the entire Java API at its disposal.

There are some important differences between an applet and a standalone Java application, including the following:

- An applet is a Java class that extends the `java.applet.Applet` class.
- A `main()` method is not invoked on an applet, and an applet class will not define `main()`.
- Applets are designed to be embedded within an HTML page.
- When a user views an HTML page that contains an applet, the code for the applet is downloaded to the user's machine.
- A JVM is required to view an applet. The JVM can be either a plug-in of the Web browser or a separate runtime environment.
- The JVM on the user's machine creates an instance of the applet class and invokes various methods during the applet's lifetime.
- Applets have strict security rules that are enforced by the Web browser. The security of an applet is often referred to as sandbox security, comparing the applet to a child playing in a sandbox with various rules that must be followed.
- Other classes that the applet needs can be downloaded in a single Java Archive (JAR) file.

Life Cycle of an Applet:

Four methods in the Applet class give you the framework on which you build any serious applet:

- **init:** This method is intended for whatever initialization is needed for your applet. It is called after the `param` tags inside the applet tag have been processed.
- **start:** This method is automatically called after the browser calls the `init` method. It is also called whenever the user returns to the page containing the applet after having gone off to other pages.

- **stop:** This method is automatically called when the user moves off the page on which the applet sits. It can, therefore, be called repeatedly in the same applet.
- **destroy:** This method is only called when the browser shuts down normally. Because applets are meant to live on an HTML page, you should not normally leave resources behind after a user leaves the page that contains the applet.
- **paint:** Invoked immediately after the start() method, and also any time the applet needs to repaint itself in the browser. The paint() method is actually inherited from the java.awt.

A "Hello, World" Applet:

The following is a simple applet named HelloWorldApplet.java:

```
import java.applet.*;
import java.awt.*;

public class HelloWorldApplet extends Applet
{
    public void paint (Graphics g)
    {
        g.drawString ("Hello World",25,50);
    }
}
```

These import statements bring the classes into the scope of our applet class:

- java.applet.Applet.
- java.awt.Graphics.

Without those import statements, the Java compiler would not recognize the classes Applet and Graphics, which the applet class refers to.

The Applet CLASS:

Every applet is an extension of the *java.applet.Applet class*. The base Applet class provides methods that a derived Applet class may call to obtain information and services from the browser context.

These include methods that do the following:

- Get applet parameters
- Get the network location of the HTML file that contains the applet
- Get the network location of the applet class directory
- Print a status message in the browser
- Fetch an image
- Fetch an audio clip
- Play an audio clip
- Resize the applet

Additionally, the Applet class provides an interface by which the viewer or browser obtains information about the applet and controls the applet's execution. The viewer may:

- request information about the author, version and copyright of the applet
- request a description of the parameters the applet recognizes
- initialize the applet
- destroy the applet
- start the applet's execution
- stop the applet's execution

The Applet class provides default implementations of each of these methods. Those implementations may be overridden as necessary.

The "Hello, World" applet is complete as it stands. The only method overridden is the paint method.

Invoking an Applet:

An applet may be invoked by embedding directives in an HTML file and viewing the file through an applet viewer or Java-enabled browser.

The <applet> tag is the basis for embedding an applet in an HTML file. Below is an example that invokes the "Hello, World" applet:

```
<html>
<title>The Hello, World Applet</title>
<hr>
<appletcode="HelloWorldApplet.class" width="320" height="120">
If your browser was Java-enabled, a "Hello, World"
message would appear here.
</applet>
<hr>
</html>
```

Based on the above examples, here is the live applet example: [Applet Example](#).

Note: You can refer to [HTML Applet Tag](#) to understand more about calling applet from HTML.

The code attribute of the <applet> tag is required. It specifies the Applet class to run. Width and height are also required to specify the initial size of the panel in which an applet runs. The applet directive must be closed with a </applet> tag.

If an applet takes parameters, values may be passed for the parameters by adding <param> tags between <applet> and </applet>. The browser ignores text and other tags between the applet tags.

Non-Java-enabled browsers do not process <applet> and </applet>. Therefore, anything that appears between the tags, not related to the applet, is visible in non-Java-enabled browsers.

The viewer or browser looks for the compiled Java code at the location of the document. To specify otherwise, use the codebase attribute of the <applet> tag as shown:

```
<applet codebase="http://amrood.com/applets"
code="HelloWorldApplet.class"width="320"height="120">
```

If an applet resides in a package other than the default, the holding package must be specified in the code attribute using the period character (.) to separate package/class components. For example:

```
<applet code="mypackage.subpackage.TestApplet.class"
width="320" height="120">
```

Getting Applet Parameters:

The following example demonstrates how to make an applet respond to setup parameters specified in the document. This applet displays a checkerboard pattern of black and a second color.

The second color and the size of each square may be specified as parameters to the applet within the document.

CheckerApplet gets its parameters in the `init()` method. It may also get its parameters in the `paint()` method. However, getting the values and saving the settings once at the start of the applet, instead of at every refresh, is convenient and efficient.

The applet viewer or browser calls the `init()` method of each applet it runs. The viewer calls `init()` once, immediately after loading the applet. (`Applet.init()` is implemented to do nothing.) Override the default implementation to insert custom initialization code.

The `Applet.getParameter()` method fetches a parameter given the parameter's name (the value of a parameter is always a string). If the value is numeric or other non-character data, the string must be parsed.

The following is a skeleton of `CheckerApplet.java`:

```
import java.applet.*;
import java.awt.*;
public class CheckerApplet extends Applet
{
    int squareSize =50;// initialized to default size
    public void init (){}
    private void parseSquareSize (String param){}
    private Color parseColor (String param){}
    public void paint (Graphics g){}
}
```

Here are `CheckerApplet`'s `init()` and private `parseSquareSize()` methods:

```
public void init ()
{
    String squareSizeParam = getParameter ("squareSize");
    parseSquareSize (squareSizeParam);
    String colorParam = getParameter ("color");
    Color fg = parseColor (colorParam);
    setBackground (Color.black);
    setForeground (fg);
}
private void parseSquareSize (String param)
{
    if(param ==null) return;
    try{
        squareSize =Integer.parseInt (param);
    }
    catch(Exception e){
        // Let default value remain
    }
}
```

The applet calls `parseSquareSize()` to parse the `squareSize` parameter. `parseSquareSize()` calls the library method `Integer.parseInt()`, which parses a string and returns an integer. `Integer.parseInt()` throws an exception whenever its argument is invalid.

Therefore, `parseSquareSize()` catches exceptions, rather than allowing the applet to fail on bad input.

The applet calls `parseColor()` to parse the color parameter into a `Color` value. `parseColor()` does a series of string comparisons to match the parameter value to the name of a predefined color. You need to implement these methods to make this applet work.

Specifying Applet Parameters:

The following is an example of an HTML file with a `CheckerApplet` embedded in it. The HTML file specifies both parameters to the applet by means of the `<param>` tag.

```
<html>
<title>Checkerboard Applet</title>
<hr>
<applet code="CheckerApplet.class" width="480" height="320">
  <param name="color" value="blue">
  <param name="squareSize" value="30">
</applet>
<hr>
</html>
```

Note: Parameter names are not case sensitive.

Application Conversion to Applets:

It is easy to convert a graphical Java application (that is, an application that uses the AWT and that you can start with the java program launcher) into an applet that you can embed in a web page.

Here are the specific steps for converting an application to an applet.

- Make an HTML page with the appropriate tag to load the applet code.
- Supply a subclass of the `JApplet` class. Make this class public. Otherwise, the applet cannot be loaded.
- Eliminate the main method in the application. Do not construct a frame window for the application. Your application will be displayed inside the browser.
- Move any initialization code from the frame window constructor to the `init` method of the applet. You don't need to explicitly construct the applet object; the browser instantiates it for you and calls the `init` method.
- Remove the call to `setSize`; for applets, sizing is done with the width and height parameters in the HTML file.
- Remove the call to `setDefaultCloseOperation`. An applet cannot be closed; it terminates when the browser exits.
- If the application calls `setTitle`, eliminate the call to the method. Applets cannot have title bars. (You can, of course, title the web page itself, using the HTML title tag.)
- Don't call `setVisible(true)`. The applet is displayed automatically.

Event Handling:

Applets inherit a group of event-handling methods from the Container class. The Container class defines several methods, such as processKeyEvent and processMouseEvent, for handling particular types of events, and then one catch-all method called processEvent.

In order to react an event, an applet must override the appropriate event-specific method.

```
import java.awt.event.MouseListener;
import java.awt.event.MouseEvent;
import java.applet.Applet;
import java.awt.Graphics;

public class ExampleEventHandling extends Applet implements MouseListener{

    StringBuffer strBuffer;

    public void init(){
        addMouseListener(this);
        strBuffer =new StringBuffer();
        addItem("initializing the apple ");
    }

    public void start(){
        addItem("starting the applet ");
    }

    public void stop(){
        addItem("stopping the applet ");
    }

    public void destroy(){
        addItem("unloading the applet");
    }

    void addItem(String word){
        System.out.println(word);
        strBuffer.append(word);
        repaint();
    }

    public void paint(Graphics g){
        //Draw a Rectangle around the applet's display area.
        g.drawRect(0,0,
            getWidth()-1,
            getHeight()-1);
        //display the string inside the rectangle.
        g.drawString(strBuffer.toString(),10,20);
    }

    public void mouseEntered(MouseEvent event){
    }
    public void mouseExited(MouseEvent event){
    }
    public void mousePressed(MouseEvent event){
    }
    public void mouseReleased(MouseEvent event){
    }
}
```

```
public void mouseClicked(MouseEvent event) {
    addItem("mouse clicked! ");
}
}
```

Now, let us call this applet as follows:

```
<html>
<title>Event Handling</title>
<hr>
<appletcode="ExampleEventHandling.class" width="300" height="300">
</applet>
<hr>
</html>
```

Initially, the applet will display "initializing the applet. Starting the applet." Then once you click inside the rectangle "mouse clicked" will be displayed as well.

Based on the above examples, here is the live applet example: [Applet Example](#).

Displaying Images:

An applet can display images of the format GIF, JPEG, BMP, and others. To display an image within the applet, you use the `drawImage()` method found in the `java.awt.Graphics` class.

Following is the example showing all the steps to show images:

```
import java.applet.*;
import java.awt.*;
import java.net.*;
public class ImageDemo extends Applet
{
    private Image image;
    private AppletContext context;
    public void init()
    {
        context =this.getAppletContext();
        String imageURL =this.getParameter("image");
        if(imageURL ==null)
        {
            imageURL ="java.jpg";
        }
        try
        {
            URL url =new URL(this.getDocumentBase(), imageURL);
            image = context.getImage(url);
        }catch(MalformedURLException e)
        {
            e.printStackTrace();
            // Display in browser status bar
            context.showStatus("Could not load image!");
        }
    }
    public void paint(Graphics g)
    {
        context.showStatus("Displaying image");
        g.drawImage(image,0,0,200,84,null);
        g.drawString("www.javalicence.com",35,100);
    }
}
```

```
}  
}
```

Now, let us call this applet as follows:

```
<html>  
<title>The ImageDemo applet</title>  
<hr>  
<appletcode="ImageDemo.class"width="300"height="200">  
<paramname="image"value="java.jpg">  
</applet>  
<hr>  
</html>
```

Based on the above examples, here is the live applet example: [Applet Example](#).

Playing Audio:

An applet can play an audio file represented by the AudioClip interface in the java.applet package. The AudioClip interface has three methods, including:

- **public void play():** Plays the audio clip one time, from the beginning.
- **public void loop():** Causes the audio clip to replay continually.
- **public void stop():** Stops playing the audio clip.

To obtain an AudioClip object, you must invoke the getAudioClip() method of the Applet class. The getAudioClip() method returns immediately, whether or not the URL resolves to an actual audio file. The audio file is not downloaded until an attempt is made to play the audio clip.

Following is the example showing all the steps to play an audio:

```
import java.applet.*;  
import java.awt.*;  
import java.net.*;  
public class AudioDemo extends Applet  
{  
    private AudioClip clip;  
    private AppletContext context;  
    public void init()  
    {  
        context =this.getAppletContext();  
        String audioURL =this.getParameter("audio");  
        if(audioURL ==null)  
        {  
            audioURL ="default.au";  
        }  
        try  
        {  
            URL url =new URL(this.getDocumentBase(), audioURL);  
            clip = context.getAudioClip(url);  
        }catch (MalformedURLException e)  
        {  
            e.printStackTrace();  
            context.showStatus("Could not load audio file!");  
        }  
    }  
    public void start()  
    {  
        if(clip !=null)  
        {
```



```
clip.loop();
}
}
public void stop()
{
if(clip !=null)
{
    clip.stop();
}
}
}
```

Now, let us call this applet as follows:

```
<html>
<title>The ImageDemo applet</title>
<hr>
<appletcode="ImageDemo.class"width="0"height="0">
<paramname="audio"value="test.wav">
</applet>
<hr>
</html>
```

You can use your test.wav at your PC to test the above example.

Java Documentation

The Java Language supports three types of comments:

Comment	Description
<code>/* text */</code>	The compiler ignores everything from <code>/*</code> to <code>*/</code> .
<code>// text</code>	The compiler ignores everything from <code>//</code> to the end of the line.
<code>/** documentation */</code>	This is a documentation comment and in general its called doc comment . The JDK javadoc tool uses <i>doc comments</i> when preparing automatically generated documentation.

This tutorial is all about explaining Javadoc. We will see how we can make use of Javadoc for generating useful documentation for our Java code.

What is Javadoc?

Javadoc is a tool which comes with JDK and it is used for generating Java code documentation in HTML format from Java source code which has required documentation in a predefined format.

Following is a simple example where red part of the code represents Java comments:

```
/**  
 * The HelloWorld program implements an application that  
 * simply displays "Hello World!" to the standard output.  
 *  
 * @author Zara Ali  
 * @version 1.0  
 * @since 2014-03-31  
 */  
public class HelloWorld {  
    public static void main(String[] args) {  
        /* Prints Hello, World! on standard output.  
        System.out.println("Hello World!");  
    }  
}
```

You can include required HTML tags inside the description part, For example, below example makes use of `<h1>...</h1>` for heading and `<p>` has been used for creating paragraph break:

```

/**
 * <h1>Hello, World!</h1>
 * The HelloWorld program implements an application that
 * simply displays "Hello World!" to the standard output.
 * <p>
 * Giving proper comments in your program makes it more
 * user friendly and it is assumed as a high quality code.
 *
 *
 * @author Zara Ali
 * @version 1.0
 * @since 2014-03-31
 */
public class HelloWorld {
    public static void main(String[] args) {
        /* Prints Hello, World! on standard output.
        System.out.println("Hello World!");
    }
}

```

The javadoc Tags:

The javadoc tool recognizes the following tags:

Tag	Description	Syntax
@author	Adds the author of a class.	@author name-text
{@code}	Displays text in code font without interpreting the text as HTML markup or nested javadoc tags.	{@code text}
{@docRoot}	Represents the relative path to the generated document's root directory from any generated page	{@docRoot}
@deprecated	Adds a comment indicating that this API should no longer be used.	@deprecated deprecated-text
@exception	Adds a Throws subheading to the generated documentation, with the class-name and description text.	@exception class-name description
{@inheritDoc}	Inherits a comment from the nearest inheritable class or implementable interface	Inherits a comment from the immediate superclass.
{@link}	Inserts an in-line link with visible text label that points to the documentation for the specified package, class or member name of a referenced class. T	{@link package.class#member label}
{@linkplain}	Identical to {@link}, except the link's label is displayed in plain text than code font.	{@linkplain package.class#member label}
@param	Adds a parameter with the specified parameter-name followed by the specified description to the "Parameters" section.	@param parameter-name description
@return	Adds a "Returns" section with the description text.	@return description
@see	Adds a "See Also" heading with a link or text entry that points to reference.	@see reference
@serial	Used in the doc comment for a default serializable field.	@serial field-description I

		include exclude
@serialData	Documents the data written by the writeObject() or writeExternal() methods	@serialData data-description
@serialField	Documents an ObjectOutputStreamField component.	@serialField field-name field-type field-description
@since	Adds a "Since" heading with the specified since-text to the generated documentation.	@since release
@throws	The @throws and @exception tags are synonyms.	@throws class-name description
{@value}	When {@value} is used in the doc comment of a static field, it displays the value of that constant:	{@value package.class#field}
@version	Adds a "Version" subheading with the specified version-text to the generated docs when the -version option is used.	@version version-text

Example:

Following program uses few of the important tags available for documentation comments. You can make use of other tags based on your requirements.

The documentation about the AddNum class will be produced in HTML file AddNum.html but same time a master file with a name index.html will also be created.

```
import java.io.*;

/**
 * <h1>Add Two Numbers!</h1>
 * The AddNum program implements an application that
 * simply adds two given integer numbers and Prints
 * the output on the screen.
 * <p>
 * <b>Note:</b> Giving proper comments in your program makes it more
 * user friendly and it is assumed as a high quality code.
 *
 * @author Zara Ali
 * @version 1.0
 * @since 2014-03-31
 */
public class AddNum {
    /**
     * This method is used to add two integers. This is
     * a the simplest form of a class method, just to
     * show the usage of various javadoc Tags.
     * @param numA This is the first paramter to addNum method
     * @param numB This is the second parameter to addNum method
     * @return int This returns sum of numA and numB.
     */
    public int addNum(int numA, int numB) {
        return numA + numB;
    }

    /**
     * This is the main method which makes use of addNum method.
     * @param args Unused.
     * @return Nothing.
     */
}
```

```

* @exception IOException On input error.
* @see IOException
*/
public static void main(String args[]) throws IOException
{
    AddNum obj = new AddNum();
    int sum = obj.addNum(10, 20);

    System.out.println("Sum of 10 and 20 is :" + sum);
}
}

```

Now, process above AddNum.java file using javadoc utility as follows:

```

$ javadoc AddNum.java
Loading source file AddNum.java...
Constructing Javadoc information...
Standard Doclet version 1.7.0_51
Building tree for all the packages and classes...
Generating /AddNum.html...
AddNum.java:36: warning - @return tag cannot be used in method with void return
type.
Generating /package-frame.html...
Generating /package-summary.html...
Generating /package-tree.html...
Generating /constant-values.html...
Building index for all the packages and classes...
Generating /overview-tree.html...
Generating /index-all.html...
Generating /deprecated-list.html...
Building index for all classes...
Generating /allclasses-frame.html...
Generating /allclasses-noframe.html...
Generating /index.html...
Generating /help-doc.html...
1 warning
$

```

You can check all the generated documentation here: [AddNum](#). If you are using JDK 1.7 then javadoc does not generate a great **stylesheet.css**, so I suggest to download and use standard stylesheet from <http://docs.oracle.com/javase/7/docs/api/stylesheet.css>

Java Library Classes

This tutorial would cover package **java.lang**, which provides classes that are fundamental to the design of

the Java programming language. The most important classes are Object, which is the root of the class hierarchy, and Class, instances of which represent classes at run time.

Here is the list of classes of ackage **java.lang**. These classes are very important to know for a Java programmer. Click a class link to know more detail about that class. For a further drill, you can refer standard Java documentation.

SN	Methods with Description
1	Boolean Boolean
2	Byte The Byte class wraps a value of primitive type byte in an object.
3	Character The Character class wraps a value of the primitive type char in an object.
4	Class Instances of the class Class represent classes and interfaces in a running Java application.
5	ClassLoader A class loader is an object that is responsible for loading classes.
6	Compiler The Compiler class is provided to support Java-to-native-code compilers and related services.
7	Double The Double class wraps a value of the primitive type double in an object.
8	Float The Float class wraps a value of primitive type float in an object.
9	Integer The Integer class wraps a value of the primitive type int in an object.
10	Long The Long class wraps a value of the primitive type long in an object.
11	Math The class Math contains methods for performing basic numeric operations such as the elementary exponential, logarithm, square root, and trigonometric functions.

12	<p>Number</p> <p>The abstract class Number is the superclass of classes BigDecimal, BigInteger, Byte, Double, Float, Integer, Long, and Short.</p>
13	<p>Object</p> <p>Class Object is the root of the class hierarchy.</p>
14	<p>Package</p> <p>Package objects contain version information about the implementation and specification of a Java package.</p>
15	<p>Process</p> <p>The Runtime.exec methods create a native process and return an instance of a subclass of Process that can be used to control the process and obtain information about it.</p>
16	<p>Runtime</p> <p>Every Java application has a single instance of class Runtime that allows the application to interface with the environment in which the application is running.</p>
17	<p>RuntimePermission</p> <p>This class is for runtime permissions.</p>
18	<p>SecurityManager</p> <p>The security manager is a class that allows applications to implement a security policy.</p>
19	<p>Short</p> <p>The Short class wraps a value of primitive type short in an object.</p>
20	<p>StackTraceElement</p> <p>An element in a stack trace, as returned by Throwable.getStackTrace().</p>
21	<p>StrictMath</p> <p>The class StrictMath contains methods for performing basic numeric operations such as the elementary exponential, logarithm, square root, and trigonometric functions.</p>
22	<p>String</p> <p>The String class represents character strings.</p>
23	<p>StringBuffer</p> <p>A string buffer implements a mutable sequence of characters.</p>
24	<p>System</p> <p>The System class contains several useful class fields and methods.</p>
25	<p>Thread</p> <p>A thread is a thread of execution in a program.</p>
26	<p>ThreadGroup</p> <p>A thread group represents a set of threads.</p>
27	<p>ThreadLocal</p> <p>This class provides thread-local variables.</p>
28	<p>Throwable</p> <p>The Throwable class is the superclass of all errors and exceptions in the Java language.</p>
29	<p>Void</p> <p>The Void class is an uninstantiable placeholder class to hold a reference to the Class object representing the Java keyword void.</p>

